

# **FURUNO**

## **OPERATOR'S MANUAL**

*VHF RADIOTELEPHONE*

Model **FM-8900S**

---

**ECF**

(Elemental Chlorine Free)

The paper used in this manual  
is elemental chlorine free.

**FURUNO ELECTRIC CO., LTD.**

9-52 Ashihara-cho,  
Nishinomiya, 662-8580, JAPAN

• FURUNO Authorized Distributor/Dealer

All rights reserved. Printed in Japan

Pub. No. OME-56800-L

(REFU ) FM-8900S

A : APR. 2012

L : JUN. 24, 2022



0 0 0 1 9 9 8 0 6 1 0

# IMPORTANT NOTICES

---

## General

- This manual has been authored with simplified grammar, to meet the needs of international users.
- The operator of this equipment must read and follow the instructions in this manual. Wrong operation or maintenance can void the warranty or cause injury.
- Do not copy any part of this manual without written permission from FURUNO.
- If this manual is lost or worn, contact your dealer about replacement.
- The contents of this manual and the equipment specifications can change without notice.
- The example screens (or illustrations) shown in this manual can be different from the screens you see on your display. The screens you see depend on your system configuration and equipment settings.
- Save this manual for future reference.
- Any modification of the equipment (including software) by persons not authorized by FURUNO will void the warranty.
- The following concern acts as our importer in Europe, as defined in DECISION No 768/2008/EC.
  - Name: FURUNO EUROPE B.V.
  - Address: Siriusstraat 86, 5015 BT, Tilburg, The Netherlands
- The following concern acts as our importer in UK, as defined in SI 2016/1025 as amended SI 2019/470.
  - Name: FURUNO (UK) LTD.
  - Address: West Building Penner Road Havant Hampshire PO9 1QY, U.K.
- All brand, product names, trademarks, registered trademarks, and service marks belong to their respective holders.

## How to discard this product

Discard this product according to local regulations for the disposal of industrial waste. For disposal in the USA, see the homepage of the Electronics Industries Alliance (<http://www.eiae.org/>) for the correct method of disposal.

## How to discard a used battery

Some FURUNO products have a battery(ies). To see if your product has a battery, see the chapter on Maintenance. If a battery is used, tape the + and - terminals of battery before disposal to prevent fire, heat generation caused by short circuit.

### In the European Union

The crossed-out trash can symbol indicates that all types of batteries must not be discarded in standard trash, or at a trash site. Take the used batteries to a battery collection site according to your national legislation and the Batteries Directive 2006/66/EU.

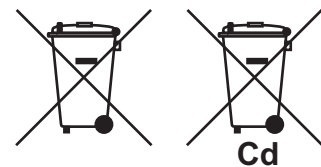

### In the USA

The Mobius loop symbol (three chasing arrows) indicates that Ni-Cd and lead-acid rechargeable batteries must be recycled. Take the used batteries to a battery collection site according to local laws.

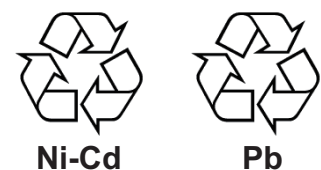

### In the other countries

There are no international standards for the battery recycle symbol. The number of symbols can increase when the other countries make their own recycle symbols in the future.



# SAFETY INSTRUCTIONS

The user must read the appropriate safety instructions before attempting to install or operate the equipment.



## WARNING

Indicates a condition that can cause death or serious injury if not avoided.



## CAUTION

Indicates a condition that can cause minor or moderate injury if not avoided.



Warning, Caution



Prohibitive Action



Mandatory Action



## WARNING



### Do not open the equipment.

Hazardous voltage which can cause electrical shock, burn or serious injury exists inside the equipment. Only qualified personnel should work inside the equipment.



### Do not approach the antenna closer than listed below when it is transmitting.

The antenna emits radio waves that can be harmful to the human body.

RF power density on antenna aperture	Distance	Description required by
100 W/m <sup>2</sup>	0.12 m	IEC 60945
10 W/m <sup>2</sup>	0.39 m	IEC 60945
2 W/m <sup>2</sup>	0.89 m	MPE by FCC

(MPE: Minimum Permissible Exposure)



### Immediately turn off the power at the switchboard if water leaks into the equipment or the equipment is emitting smoke or fire.

Continued use of the equipment can cause fire or electrical shock. Contact a FURUNO agent for service.



### Do not disassemble or modify the equipment.

Fire, electrical shock or serious injury can result.



### Do not place liquid-filled containers on the top of the equipment.

Fire or electrical shock can result if a liquid spills into the equipment.



## WARNING



### Do not operate the equipment with wet hands.

Electrical shock can result.



### Turn off the power immediately if you feel the equipment is behaving abnormally.

Turn off the power at the switchboard if the equipment becomes abnormally warm or is emitting odd noises. Contact a FURUNO dealer or agent for advice.



### Make sure no rain or water splash leaks into the equipment.

Fire or electrical shock can result if water leaks in the equipment.



### Use the proper fuse.

Use of the wrong fuse can cause fire or electrical shock.





### Any repair work must be done by a licensed radio technician.



Improper repair work can cause fire or electrical shock.



### Do not operate the [DISTRESS] key except in case of a life-endangering situation on your vessel.

Operating the [DISTRESS] key transmits the distress alert. Accidental transmission may prevent search and rescue operations for actual emergency. If the distress alert is accidentally transmitted, contact the nearest station to cancel the alert.

 <b>CAUTION</b>	
	If the distress alert is accidentally transmitted, contact the nearest coast station and inform them of the accidental transmission, providing the following data:
	<ul style="list-style-type: none"> <li>a) Ship's name</li> <li>b) Ship's call sign and DSC number</li> <li>c) Position at time of transmission</li> <li>d) Time of transmission</li> </ul>

 <b>CAUTION</b>	
	<b>Do not touch any part of the antenna when the equipment is transmitting.</b> Electrical shock can result.
	<b>Do not apply strong pressure to the LCD, which is made of glass.</b> Injury can result if the LCD breaks.

### WARNING LABELS

Warning labels are attached to the equipment. Do not remove any label. If a label is missing or damaged, contact a FURUNO agent or dealer about replacement.

 <b>WARNING</b> 	
To avoid electrical shock, do not remove cover. No user-serviceable parts inside.	
 <b>警告</b> 	
感電の恐れあり。 サービスマン以外の方はカバーを開けないで下さい。内部には高電圧部分が多くあり、万ざわると危険です。	

Name: Warning Label 1  
Type: 86-003-1011-3  
Code No.: 100-236-233-10

 <b>DANGER</b>	
	<b>Electrical shock hazard.</b> Do not touch parts inside this cover.
	 <b>危険</b>
感電の恐れあり。 カバーの内部には、絶対に触れないで下さい。	

Name: Warning Label  
Type: 14-055-4202-1  
Code No.: 100-245-221-10



Name: High Temp Warning Label  
Type: 05-089-2142-0  
Code No.: 100-301-620-00

### — About the TFT LCD —

The TFT LCD is constructed using the latest LCD techniques, and displays 99.99% of its pixels. The remaining 0.01% of the pixels may drop out or blink, however this is not an indication of malfunction.

# DISTRESS ALERT

## How to send a distress alert

Below is the procedure for transmitting a distress alert via radiotelephone. Transmit the distress alert when a life-endangering situation occurs on your vessel.

1. Open the **DISTRESS** key cover then press and hold the **DISTRESS** key for four seconds.

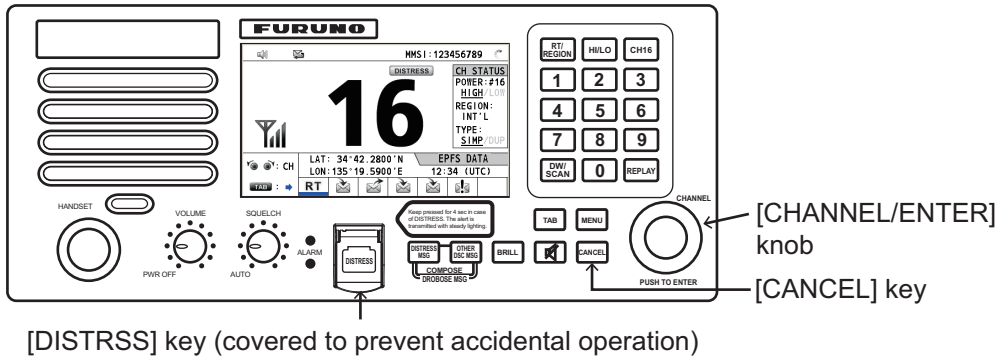

While pressing the key, the following screen appears.

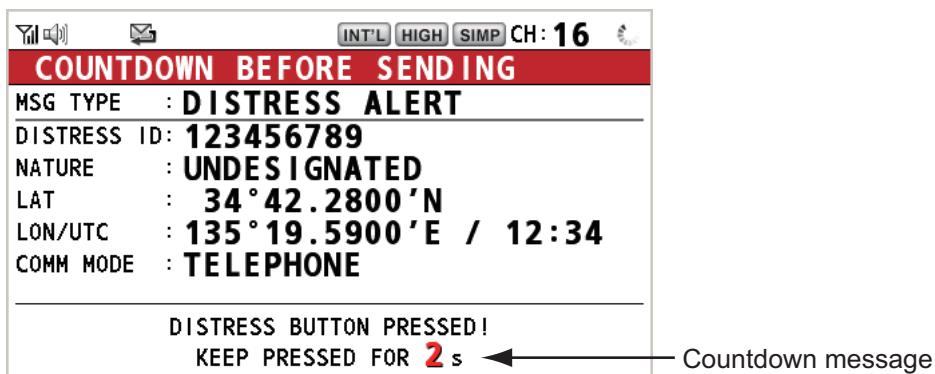

2. When the message "Sending DISTRESS ALERT." appears on the screen, release the **DISTRESS** key. The audio alarm sounds for two seconds. After the distress alert has been sent, the following screens appear in order.

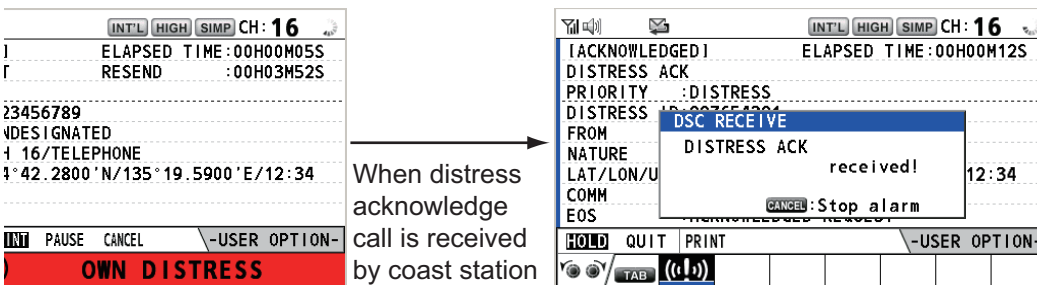
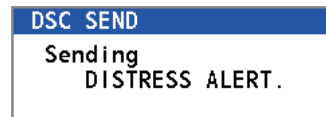

3. When the distress acknowledge call is received by a coast station, the audio alarm sounds. Press the **CANCEL** key to silence the audio alarm.
4. Communicate with the coast station via radiotelephone (CH16) as below.
  - a) Say "MAYDAY" three times.
  - b) Say "This is..." name of your ship and call sign three times.
  - c) Give nature of distress and assistance needed.
  - d) Give description of your ship (type, color, number of persons onboard, etc.).

**Note:** If you do not receive the distress alert acknowledge call, the equipment automatically re-transmits the distress alert after 3 min 30 seconds to 4 min 30 seconds. Then the equipment awaits the distress alert acknowledge call. This is repeated until the distress alert is acknowledged.

### How to cancel the distress alert

You can cancel the distress alert while waiting for its acknowledgment as follows.

1. Rotate the **CHANNEL/ENTER** knob to select [CANCEL] in the user options area then push the knob.

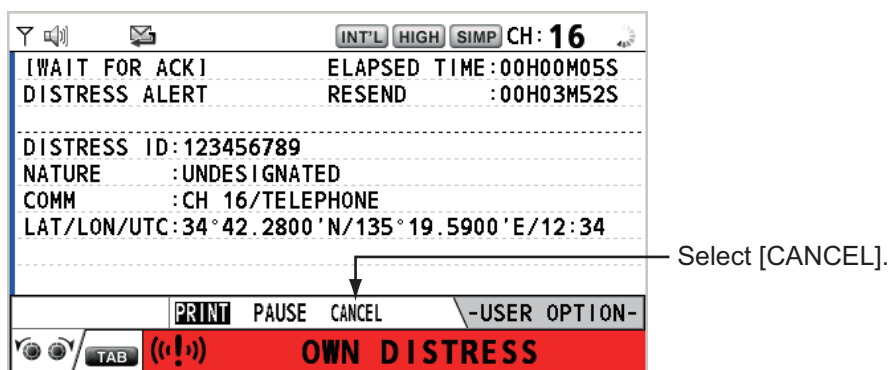

The message shown right appears on the screen.

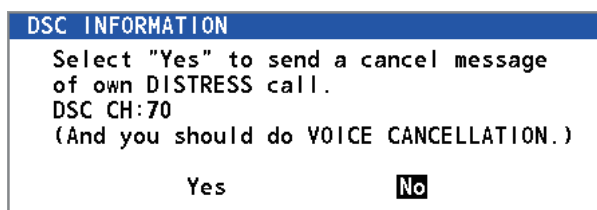

2. Rotate the **CHANNEL/ENTER** knob to select [Yes] then push the knob to send the distress cancel call on CH70. After transmitting the distress cancel call, the message shown right appears on the screen.
3. Push the **CHANNEL/ENTER** knob to erase the message. The message shown right appears on the screen.

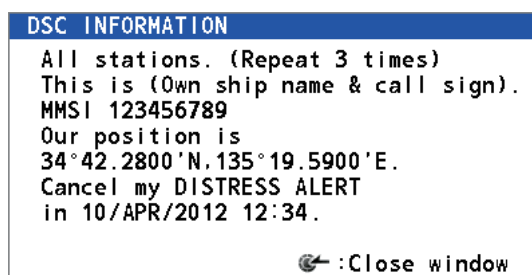
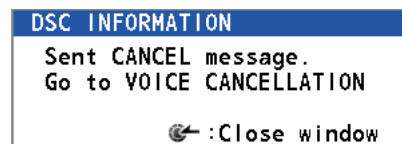

4. Communicate with all ships via radiotelephone referring to the message at step 3.
5. Push the **CHANNEL/ENTER** knob. The message shown right appears on the screen.

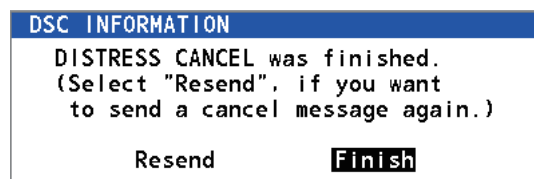

6. With [Finish] selected, push the **CHANNEL/ENTER** knob.

# TABLE OF CONTENTS

---

<b>FOREWORD .....</b>	<b>ix</b>
<b>SYSTEM CONFIGURATION .....</b>	<b>xi</b>
<b>1. OPERATIONAL OVERVIEW .....</b>	<b>1-1</b>
1.1 Controls.....	1-1
1.2 How to Turn On/Off the Power.....	1-2
1.3 Radiotelephone (RT) Screen .....	1-2
1.4 How to Adjust the Brilliance of the Display and Panel .....	1-3
1.5 How to Select the Channel Region, Channel.....	1-4
1.6 Transmission.....	1-5
1.7 How to Turn On/Off the Loudspeaker .....	1-5
1.8 Quick Selection of CH16.....	1-5
1.9 How to Scan Dual Channels (DW).....	1-6
1.10 How to Scan All Channels.....	1-7
1.11 How to Set the Auto Acknowledgment.....	1-8
1.12 Priority of the System .....	1-8
1.13 Intercom .....	1-9
1.14 Operation of Session.....	1-10
1.15 Replay Function .....	1-14
<b>2. DSC OVERVIEW.....</b>	<b>2-1</b>
2.1 What is DSC?.....	2-1
2.2 DSC Messages .....	2-1
2.3 Audio Alarms.....	2-2
2.4 Description of Call Screens.....	2-3
2.4.1 RX calls .....	2-3
2.4.2 TX calls .....	2-4
<b>3. DSC DISTRESS OPERATIONS .....</b>	<b>3-1</b>
3.1 How to Send a Distress Alert .....	3-1
3.1.1 How to send a distress alert by DISTRESS key with distress information not edited .....	3-1
3.1.2 How to send a distress alert by DISTRESS key with distress information edited .....	3-3
3.2 How to Receive a Distress Alert.....	3-4
3.3 How to Send a Distress Relay on Behalf of a Ship in Distress .....	3-10
3.3.1 How to send a distress relay to a coast station.....	3-10
3.3.2 How to send a distress relay to all ships .....	3-11
3.4 How to Receive a Distress Relay.....	3-13
3.5 How to Cancel the Distress Alert .....	3-13
3.6 How to Handle Messages From the MOB Device.....	3-15
3.6.1 How to acknowledge a DISTRESS RELAY or DISTRESS ALERT message from the MOB device.....	3-16
<b>4. DSC GENERAL MESSAGE CALLING, RECEIVING.....</b>	<b>4-1</b>
4.1 Individual Call.....	4-1
4.1.1 How to send an individual call.....	4-1
4.1.2 How to receive an individual call .....	4-4
4.2 Group Call.....	4-6
4.2.1 How to send a group call.....	4-6
4.2.2 How to receive a group call.....	4-7
4.3 PSTN Call .....	4-8



4.3.1	How to send a PSTN call .....	4-8
4.3.2	How to receive a PSTN call.....	4-10
4.3.3	Caution for a PSTN call.....	4-10
4.4	All Ships Call .....	4-11
4.4.1	How to send an all ships call .....	4-11
4.4.2	How to receive an all ships call .....	4-12
4.5	Position Call.....	4-13
4.5.1	How to request other ship's position.....	4-13
4.5.2	Other ship requests your position.....	4-15
4.6	How to Receive a Polling Request .....	4-15
4.6.1	Automatic reply.....	4-15
4.6.2	Manual reply .....	4-16
4.7	Neutral Craft Call .....	4-16
4.7.1	How to send a neutral craft call .....	4-16
4.7.2	How to receive a neutral craft call .....	4-17
4.8	Medical Transport Call.....	4-18
4.8.1	How to send a medical transport call .....	4-18
4.8.2	How to receive a medical transport call.....	4-19
4.9	Auto Channel Switching .....	4-20
<b>5.</b>	<b>MENU OPERATION .....</b>	<b>5-1</b>
5.1	How to Open/Close the MENU Screen .....	5-1
5.2	Handset Volume Setting.....	5-2
5.3	Channel Setting .....	5-2
5.3.1	Channel region .....	5-2
5.3.2	Memory .....	5-2
5.4	Memory Configuration .....	5-3
5.5	How to Print Messages.....	5-4
5.6	Position Setting.....	5-4
5.6.1	How to adjust the EPFS alarm message timing .....	5-5
5.6.2	Position source priority .....	5-5
5.7	Date and Time Setting.....	5-6
5.8	Timeout Setting .....	5-6
5.9	How to Name the Terminal for Intercom.....	5-7
5.10	Automatic Switch to CH16.....	5-8
5.11	External Alarm Setting.....	5-8
5.12	RT Application Setting.....	5-9
5.13	Address Book .....	5-10
5.13.1	List for address data .....	5-10
5.13.2	How to register addresses.....	5-11
5.13.3	How to edit addresses .....	5-12
5.13.4	How to delete addresses .....	5-13
5.13.5	How to create a DSC message with registered address .....	5-13
5.14	TX Message Preparation.....	5-14
5.14.1	List for message files.....	5-14
5.14.2	Individual calls .....	5-15
5.14.3	Group calls .....	5-16
5.14.4	PSTN calls.....	5-17
5.14.5	Test calls .....	5-18
5.14.6	How to edit prepared messages.....	5-18
5.14.7	How to send prepared messages.....	5-19
5.14.8	How to delete prepared messages.....	5-19
5.15	Log File.....	5-20
5.15.1	How to open a log file .....	5-20
5.15.2	How to delete log files .....	5-21
5.16	How to Set the AUTO ACK Details.....	5-22

## TABLE OF CONTENTS

5.17 Special Messages .....	5-22
5.18 Propose Channel Setting .....	5-23
5.19 Sound Setting.....	5-23
5.20 Alarm Lists .....	5-24
<b>6. REMOTE HANDSET .....</b>	<b>6-1</b>
6.1 Controls.....	6-1
6.2 How to Turn On/Off the Power.....	6-2
6.3 Radiotelephone (RT) Screen .....	6-2
6.4 How to Adjust the Brilliance and Contrast.....	6-3
6.5 How to Select the Channel Region, Channel.....	6-3
6.6 Transmission.....	6-4
6.7 How to Turn On/Off the Loudspeaker .....	6-5
6.8 Quick Selection of CH16 .....	6-5
6.9 Intercom .....	6-5
6.10 How to Change the Terminal ID.....	6-6
6.11 Audio setting .....	6-7
6.12 How to Test FM-8900S from a Remote Handset.....	6-8
6.13 How to Display the Program Versions .....	6-8
6.14 Squelch .....	6-8
<b>7. MAINTENANCE &amp; TROUBLESHOOTING .....</b>	<b>7-1</b>
7.1 Daily Test .....	7-1
7.2 Maintenance.....	7-2
7.3 Simple Troubleshooting .....	7-2
7.4 Test Call.....	7-3
<b>APPX. 1 MENU TREE .....</b>	<b>AP-1</b>
<b>APPX. 2 MARINE VHF CHANNEL LISTS .....</b>	<b>AP-3</b>
<b>APPX. 3 ABBREVIATIONS AND ICONS .....</b>	<b>AP-13</b>
<b>APPX. 4 DIGITAL INTERFACE .....</b>	<b>AP-16</b>
<b>APPX. 5 PARTS LIST .....</b>	<b>AP-24</b>
<b>APPX. 6 PARTS LOCATION .....</b>	<b>AP-26</b>
<b>APPX. 7 THERMAL PRINTER UTP-58E .....</b>	<b>AP-28</b>
<b>APPX. 8 ALERT LIST AND CODES .....</b>	<b>AP-31</b>
<b>SPECIFICATIONS .....</b>	<b>SP-1</b>
<b>INDEX.....</b>	<b>IN-1</b>

# FOREWORD

---

## A Word to the Owner of the FM-8900S

Congratulations on your choice of the FURUNO FM-8900S VHF Radiotelephone. We are confident you will see why the FURUNO name has become synonymous with quality and reliability.

Since 1948, FURUNO Electric Company has enjoyed an enviable reputation for innovative and dependable marine electronics equipment. This dedication to excellence is furthered by our extensive global network of agents and dealers.

Your equipment is designed and constructed to meet the rigorous demands of the marine environment. However, no machine can perform its intended function unless properly installed and maintained. Please carefully read and follow the operation and maintenance procedures set forth in this manual.

We would appreciate feedback from you, the end-user, about whether we are achieving our purposes.

Thank you for considering and purchasing FURUNO equipment.

## Features

The FM-8900S is a cost-effective all-in-one marine VHF radio system consisting of a 25 W VHF radiotelephone, a DSC modem, and a CH70 watchkeeping receiver. It complies with GMDSS carriage requirements for safety and general communications.

The FM-8900S offers simplex or semi-duplex voice communication on ITU channels in the marine mobile VHF band. The features include Scanning Dual Channels (DW) which allows a continuous watch on CH16 and another selected frequency.

Data is displayed on a large, easy-to-read color LCD. Operation is simplified by the use of few keys and easy-to-follow menus.

The built-in DSC function produces and receives digital selective callings for quick and efficient establishment of distress, urgency, safety and routine communications with other ships and coast stations that install any VHF DSC facilities.

Full Class-A DSC functions are provided for distress alert transmission and reception, as well as the safety call, urgency call, and general call formats (Individual telephone, Group call). Distress alert can be readily transmitted but an arrangement is provided to prevent accidental activation. The FM-8900S maintains a continuous watch on CH70 even while another VHF channel is in use. Aural and visual alarms are given to incoming DSC messages.

The main features are

### General

- Fully meets the following regulations: EN 300 698-1, EN 301 925, ITU-R M.493, ITU-R M.541, ITU-R M.689, EN 300 338-1, EN 300 338-2, IEC62923-1/2 (Type p).
- Automatic entry of position as well as manual entry
- Optional printer can automatically print out DSC received messages and test results.

## FOREWORD

### **DSC**

- Distress, urgency, safety and routine calling
- In-advance file editing capability
- PSTN (Public Switched Telephone Network) capability standard
- Log stores 50 each of latest general, distress and transmitted messages, in separate memory blocks.
- Selectable an address from the AIS targets list with connection of FURUNO AIS Transponder/ Receiver

### **VHF**

- Voice communication
- Scanning of channels on VHF
- Simplified setting of channel
- Replay of the latest receiving voice, which is automatically recorded, for 120 seconds
- Max. 4 remote stations (RB-8900) can be connected (not available for DSC function).

## **Program Number**

<b>Location</b>	<b>PC board</b>	<b>Program No.</b>	<b>Version</b>
FM-8900S	MAIN (05P0843)	0550249	05.xx
HS-8900	HS CONT (05P0781B)	0550250	02.xx

xx: minor change

## **CE/UKCA declaration**

With regards to CE/UKCA declarations, please refer to our website ([www.furuno.com](http://www.furuno.com)), for further information about RoHS conformity declarations.

## **Disclosure of Information about China RoHS**

With regards to China RoHS information for our products, please refer to our website ([www.furuno.com](http://www.furuno.com)).

# SYSTEM CONFIGURATION

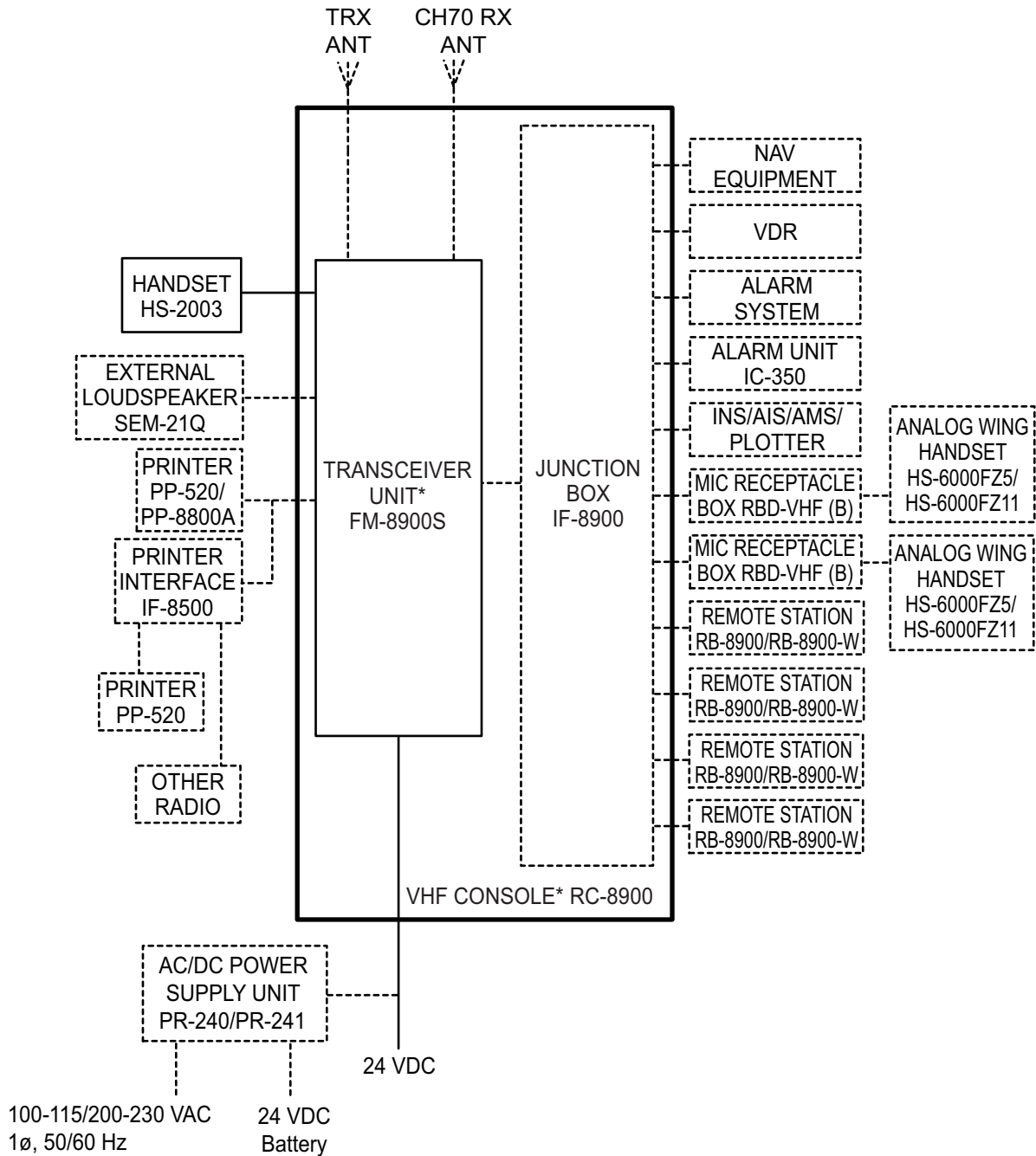

Environmental category

Antenna units: Exposed to the weather

All other units: Protected from the weather

This page is intentionally left blank.

# 1. OPERATIONAL OVERVIEW

## 1.1 Controls

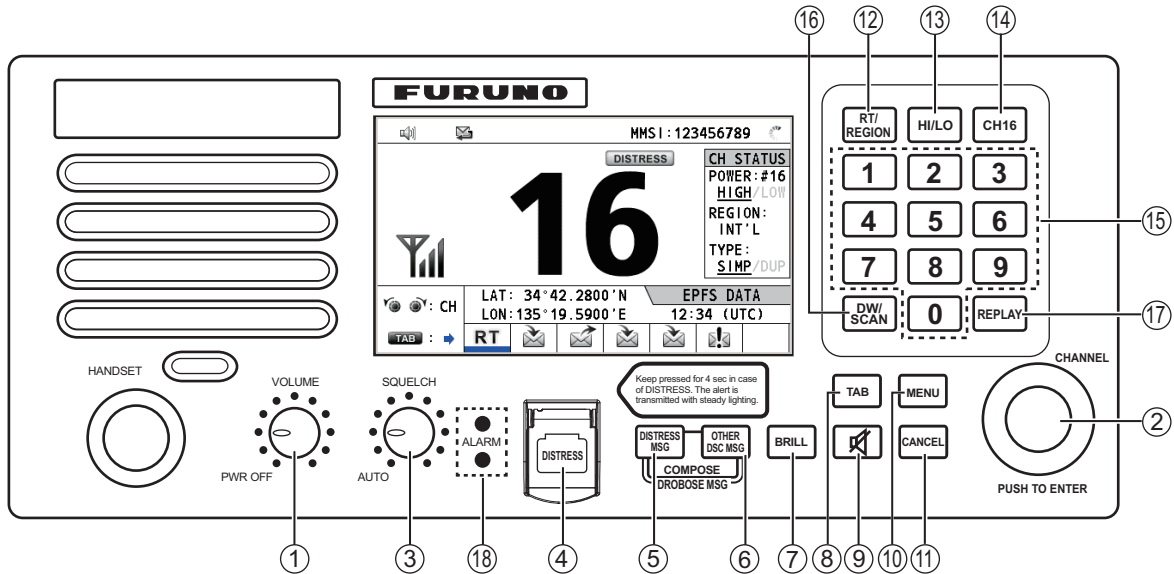

Transceiver unit

### Description of controls for transceiver unit

No.	Control	Function
1	<b>VOLUME/PWR</b> knob	<ul style="list-style-type: none"> <li>Turns the power on or off.</li> <li>Adjusts the volume.</li> </ul>
2	<b>CHANNEL/ENTER</b> knob	<ul style="list-style-type: none"> <li>Rotate to select channel.</li> <li>Rotate to select menu items or change the page in multi-page screens (e.g., log data); push to confirm a selection.</li> </ul>
3	<b>SQUELCH</b> knob	Rotate to adjust the squelch. The squelch mutes the audio output in the absence of an incoming signal. AUTO position automatically reduces white noise.
4	<b>DISTRESS</b> key	Press and hold down the key four seconds to transmit the distress alert.
5	<b>DISTRESS MSG</b> key	Composes DSC TX message for DISTRESS ALERT.
6	<b>OTHER DSC MSG</b> key	Composes DSC TX message except DISTRESS ALERT and DROBOSE (Distress Relay On Behalf Of Someone Else).
5, 6	<b>DROBOSE MSG</b> key	Composes DSC TX message for DROBOSE (Distress Relay On Behalf Of Someone Else). Press the <b>DISTRESS MSG</b> key and the <b>OTHER DSC MSG</b> key simultaneously.
7	<b>BRILL</b> key	Adjusts the brilliance.
8	<b>TAB</b> key	<ul style="list-style-type: none"> <li>Switches control to the tab area.</li> <li>Switches the session.</li> </ul>
9	🔊 key	Turns the main speaker on or off.
10	<b>MENU</b> key	<ul style="list-style-type: none"> <li>Opens/closes the menu.</li> <li>Long press to open alert list.</li> </ul>

*Continued on following page.*

No.	Control	Function
11	<b>CANCEL</b> key	<ul style="list-style-type: none"> <li>• Cancels the creation of the DSC message currently being created.</li> <li>• Silences the audio alarm.</li> <li>• Erases alert and pop-up messages.</li> <li>• Returns previous layer in multi-layer menu.</li> <li>• Erases character input.</li> </ul>
12	<b>RT/REGION</b> key	<ul style="list-style-type: none"> <li>• Switches to the RT (radiotelephone) screen.</li> <li>• Opens/closes the option window for channel region.</li> </ul>
13	<b>HI/LO</b> key	Changes the output power to high (25 W) or low (1 W).
14	<b>CH16</b> key	Switches to the RT (radiotelephone) screen and sets CH16.
15	<b>0 to 9</b> keys	<ul style="list-style-type: none"> <li>• Enter alphabet, numeric or symbol.</li> <li>• Direct selection of corresponding function on menu and applicable screens.</li> </ul>
16	<b>DW/SCAN</b> key	<ul style="list-style-type: none"> <li>• Opens the option window for DW or SCAN.</li> <li>• Cancels DW or SCAN in process.</li> </ul>
17	<b>REPLAY</b> key	Opens the replay screen.
18	ALARM lamps	Top: Flashes in red when receiving distress alert, distress and urgency messages. Bottom: Flashes in green when receiving safety and routine messages, and when daily test is completed. The flashing of a lamp for receiving a DSC message is in sync with the audio alarm. The flashing cycle for both top and bottom lamps is 200 msec (lighting) → 200 msec (off) → 200 msec (lighting) → 200 msec (off) → ...

## 1.2 How to Turn On/Off the Power

Rotate the **VOLUME/PWR** knob clockwise to turn on the power. The RT screen appears.



To turn off the power, rotate the **VOLUME/PWR** knob counterclockwise to the OFF position.

## 1.3 Radiotelephone (RT) Screen

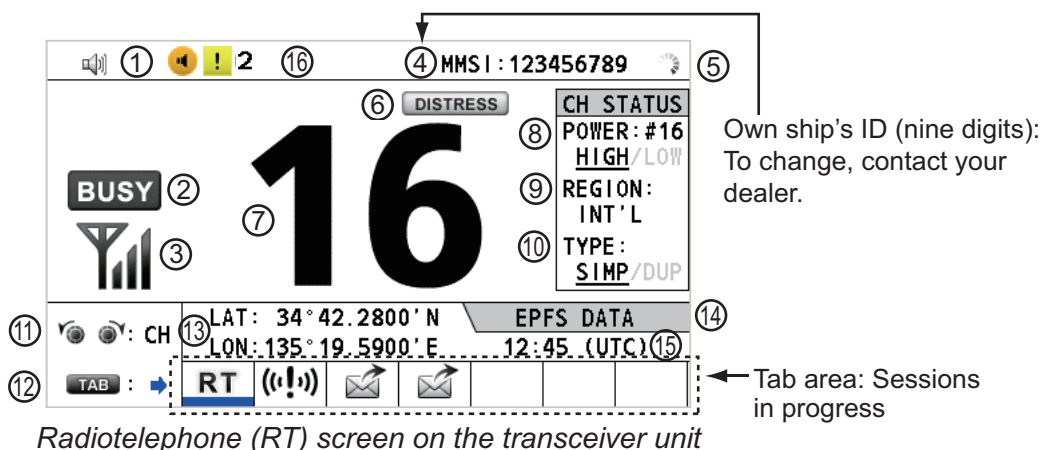
Turn the power on, or press the **RT/REGION** key to show the radiotelephone (RT) screen. This is where you set up the transceiver unit, and communicate by voice.





No.	Meaning
1	Loudspeaker on (  ) or off (  )
2	This icon appears when the signal is received.
3	Intensity of reception (This icon does not appear while transmitting.)
4	Own ship's ID (nine digits) <b>Note:</b> To change, contact your dealer.
5	Spinner rotates when the equipment is functioning normally.
6	This icon appears when the frequency is for distress.
7	Channel
8	Output power ([HIGH], [LOW])
9	Channel region ([INT'L], [USA], [CANADA], [INLAND-W], [PRIVATE])
10	Channel type ([SIMP]: Simplex, [DUP]: Duplex)
11	Guidance: Rotate the <b>CHANNEL/ENTER</b> knob to select channel.
12	Guidance: Press the <b>TAB</b> key to switch the session.
13	Own ship's position (LAT: Latitude, LON: Longitude)
14	Method of data input [EPFS DATA]: The position and time data from EPFS. [EPFS (OFFLINE)]: Indicates no position data from EPFS for ten minutes. [EPFS (OLD)]: Indicates no position data from EPFS for four hours. [MANUAL INPUT]: Set the position and time data manually. [NO INFO]: No position and time data.
15	Time (UTC: universal time coordinated) of the position fix
16	Indicates the number of total alerts (WARNING and CAUTION) currently occurring.

## 1.4 How to Adjust the Brilliance of the Display and Panel

You can adjust the brilliance of the display and the panel for transceiver unit.

1. Press the **BRILL** key to show the [BRILL LEVEL SETUP] window.  
If necessary, press the **1** key to switch the [DAY/NIGHT] mode.

**Note:** When switching the [DAY/NIGHT] mode with the **1** key, the [BRILL LEVEL SETUP] window closes. Press the **BRILL** key again to show the window.

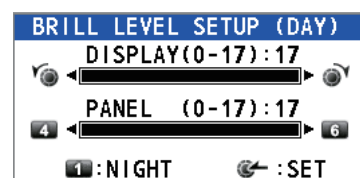

2. To adjust the [DISPLAY] brilliance, rotate the **CHANNEL/ENTER** knob or press the **BRILL** key. (Default setting: 17 for [DAY], 7 for [NIGHT])
3. To adjust the [PANEL] brilliance, press the **4** (decrease the setting) or **6** (increase the setting) key. (Default setting: 17 for [DAY], 12 for [NIGHT])
4. Push the **CHANNEL/ENTER** knob to save the settings and close the window. To cancel the settings, press the **CANCEL** key instead of the **CHANNEL/ENTER** knob to close the window.

**Note 1:** The equipment keeps values for [DAY] and [NIGHT] separately.

**Note 2:** The window closes automatically when there is no operation for four seconds.

**Note 3:** When you turn on the power with the display brilliance set to 0, the setting automatically changes to 1.

## 1.5 How to Select the Channel Region, Channel

### Channel region

You can select the channel region by the **RT/REGION** key or the [REGION] menu.

#### By the RT/REGION key

1. Press the **RT/REGION** key to open the [REGION] option on the RT screen.
2. Rotate the **CHANNEL/ENTER** knob to select the channel region desired then push the knob.



#### By the [REGION] menu

See subsection 5.3.1.

1. Press the **MENU** key to open the [MENU] screen.
2. Rotate the **CHANNEL/ENTER** knob to select [CH MODE] then push the knob.
3. Rotate the **CHANNEL/ENTER** knob to select [REGION] then push the knob.
4. Rotate the **CHANNEL/ENTER** knob to select the channel region desired then push the knob.



Only permitted channel regions are displayed, which are set by the installer of the equipment.

The following options are available.

- [INT'L]: International mode
- [USA]: USA mode
- [CANADA]: CANADA mode
- [INLAND-W]: Inland waterway mode
- [PRIVATE]: Private channel mode

**Note:** Private channels are available only where permitted by the authorities.

### Channel

The channel can be set manually on the RT screen. Enter the channel by one of the methods below.

Enter channel with the CHANNEL/ENTER knob:

Rotate the **CHANNEL/ENTER** knob on the RT screen.

Enter channel with the numeric keys:

Use the numeric keys to enter channel on the RT screen then push the **CHANNEL/ENTER** knob. The setting is automatically confirmed two seconds after entering, without pushing the **CHANNEL/ENTER** knob.

## 1.6 Transmission

### How to transmit

Press the **PTT** (push-to-talk) switch on the handset with off hook to talk, and release it to listen for a response. "TX" appears on the screen during transmission.

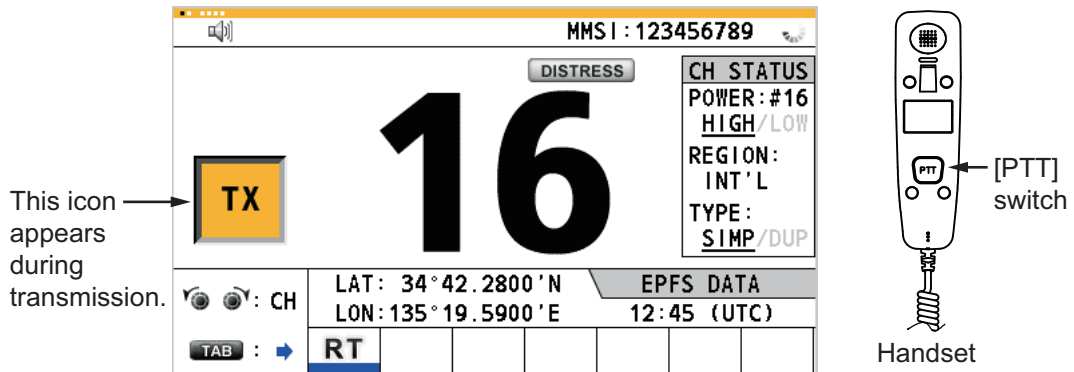

### How to change the output power

Press the **HI/LO** key to change the output power between high and low alternately. [HIGH] or [LOW] with underline appears in the [CH STATUS] area on the RT screen depending on your selection.

## 1.7 How to Turn On/Off the Loudspeaker

You can turn the loudspeaker (other than DSC communication, alert, and key beep) on or off.

1. Press the  key to alternately disable or enable the loudspeaker.



2. To adjust the volume of the loudspeaker, rotate the **VOLUME/PWR** knob (clockwise: volume up, counter-clockwise: volume down).

## 1.8 Quick Selection of CH16

Press the **CH16** key to select CH16. The CH16 (156.8 MHz) is the international frequency for distress traffic and for calling by radiotelephone. The CH16 can also be used by ship stations for call and reply. To facilitate the reception of distress calls and distress traffic, all transmissions on CH16 should be kept to a minimum and should not exceed one minute. Before transmitting on the CH16, a station should listen on this frequency for a reasonable period to make sure that no distress traffic is being sent.

## 1.9 How to Scan Dual Channels (DW)

The DW function permits watch on CH16 and an operator-selected channel. CH16 and another channel are watched at intervals of 0.15 seconds and one second, respectively.

1. Select the other channel to watch then press the **DW/SCAN** key to show the [DW/SCAN] option.



2. With [DW] selected, push the **CHANNEL/ENTER** knob. The following screen appears (channel 68 is selected in the example).

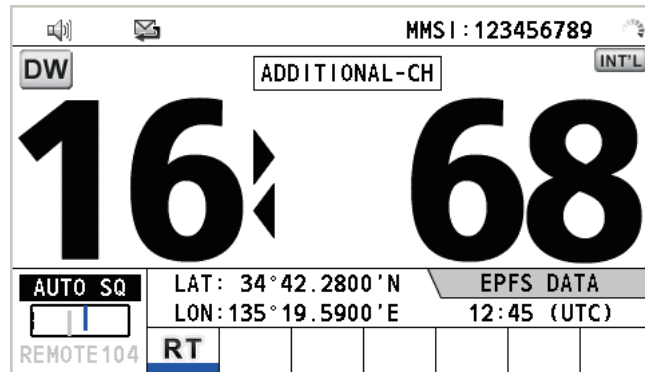

When the receiver detects a carrier and the squelch opens, the following occurs.

- When the squelch opens on the additional channel, the receiver continues scanning dual channels.
- When the squelch opens on the CH16, the CH16 is set.

When the squelch closes, the scanning on dual channels restarts.

To stop the scanning on dual channels, do one of the following:

- Press the **CANCEL** key.
- Press the **CH16** key.
- Press the **DISTRESS** key.
- Press the **DW/SCAN** key.
- Off hook a handset if there is one on hook.
- Press the **PTT** switch of a handset that is off hook. In this case, press the **PTT** switch again to transmit.
- Activate another session.
- Select [HOLD] in the RT session.
- Select [QUIT] in the RT session.
- Press the **MENU** key.
- Press the **RT/REGION** key.

## 1.10 How to Scan All Channels

The receiver scans all channels at intervals of 0.15 seconds in the selected channel mode in ascending channel order, watching CH16 between channels as below:

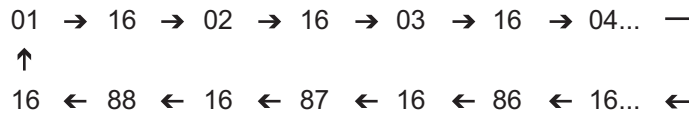

**Note:** TX is disabled when scanning.

1. Press the **DW/SCAN** key to show the [DW/SCAN] option.



2. With [SCAN] selected, push the **CHANNEL/ENTER** knob. The scanning starts and the "SCAN" icon appears on the screen.

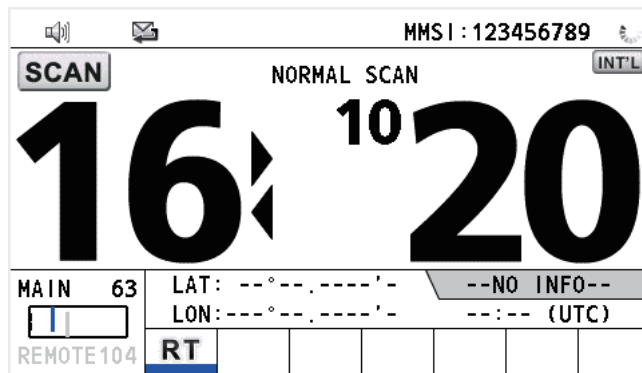

When the receiver detects a carrier and the squelch opens, the scanning is stopped on that channel.

- When the squelch opens on the channel except CH16, dual watch starts on it and CH16.
- When the squelch opens on the CH16, the CH16 is set.

When the squelch closes, the scanning restarts.

To stop the scanning, do one of the following:

- Press the **CANCEL** key.
- Press the **CH16** key.
- Press the **DISTRESS** key.
- Press the **DW/SCAN** key.
- Off hook a handset if there is one on hook.
- Press the **PTT** switch of a handset that is off hook. In this case, press the **PTT** switch again to transmit.
- Activate another session.
- Select [HOLD] in the RT session.
- Select [QUIT] in the RT session.
- Press the **MENU** key.
- Press the **RT/REGION** key.

## 1.11 How to Set the Auto Acknowledgment

Individual, PSTN (public switched telephone network), position, polling and test calls can be acknowledged automatically or manually. This is set on the [ACK SETTINGS] in the [DSC] menu (see section 5.16).

**Note:** When own ship's communication is high priority, set to manual acknowledgment. The auto acknowledgment is not sent in the following cases:

- Other session is active.
- There are RT or DSC sessions (for individual call).
- Channel is in use.
- ECC is NG (No Good).

**Note:** The auto acknowledgment for the individual call is sent only when the proposed channel or communication mode is not available.

## 1.12 Priority of the System

If one or more remote stations are installed, the transceiver unit has the highest priority. You can interrupt remote handset operation at any time with the handset of the main unit. When you hook off the handset of the main unit, "OCCUPIED BY: FM-8900S" (Default. This can be changed.) is indicated on all remote handsets. Each remote handset has its own priority. The remote handset ID (1-4) indicates its priority. The priority of the system is as follows:

Transceiver unit = Analog wing handset > Digital wing handset L = Digital wing handset R > Remote handset 1 > Remote handset 2 > Remote handset 3 > Remote handset 4.

If you hook off No.4 remote handset, for example, "IN USE BY: HANDSET\_P4" is displayed on other remote handsets and "HANDSET\_P4: OPERATION" on the transceiver unit. However, you can hook off and use No.1 remote handset.

The terminal which you operate has priority in the following conditions:

- The handset goes off hook.
- Display the menus or setting windows.
- Display each function screen (for example, Log).
- Switch the session.
- Press a key or rotate the **CHANNEL/ENTER** knob. (The priority is lost after four seconds.)

### How to set the terminal ID

1. Disconnect the remote handset from the terminal to turn off the remote handset.
2. While pressing the **MENU** key of a remote handset, connect the plug to turn on the power.
3. Enter the terminal ID, using the **1** to **6** keys, then press the **ENTER** key. Do not assign the same number to multiple remote handsets. If the handset is used as a wing handset, assign terminal ID 5 to the left-side handset and terminal ID 6 to the right-side handset.

- Disconnect the handset from the terminal, then reconnect the handset to complete the setup procedure.

**Note:** You can also restart the FM-8900S unit to complete the setup procedure.

## 1.13 Intercom

The built-in intercom permits voice communications between two terminals.

### Calling

You can call over the intercom in on or off hook condition.

- Press the **MENU** key to open the [MENU] screen.

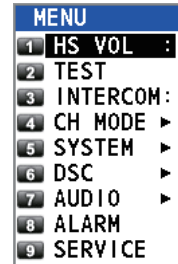

- Rotate the **CHANNEL/ENTER** knob to select [INTERCOM] then push the knob.



- Rotate the **CHANNEL/ENTER** knob to select the called party's terminal then push the knob. The called party's terminal rings. To cancel calling, press the **CANCEL** key.



- When the called party picks up their handset, the following screen appears.

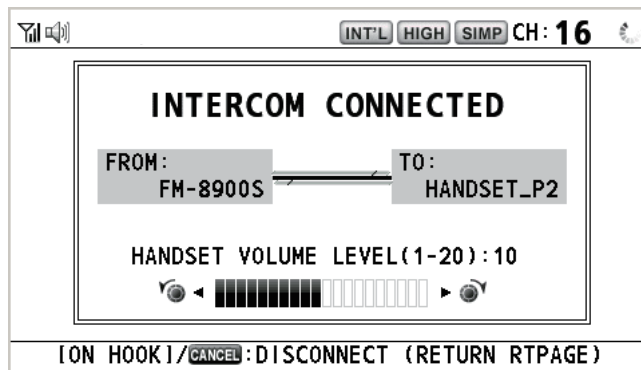

Start communications.

**Note:** You do not have to press the **PTT** switch to communicate.

- If needed, adjust the handset volume by rotating the **CHANNEL/ENTER** knob.
- Hang up the handset or press the **CANCEL** key to turn the intercom off. The last-used screen appears.

## 1. OPERATIONAL OVERVIEW

### Answering

1. The terminal rings and the following screen appears. To cancel reply, press the **CANCEL** key.

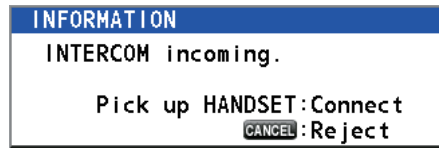

2. Pick up the handset to start communications.
3. Hang up the handset or press the **CANCEL** key to turn the intercom off. The last-used screen appears.

## 1.14 Operation of Session

### Description of session

There are two types of sessions: RT session and DSC session. When a session starts, the applicable icon for the session appears in the tab area.

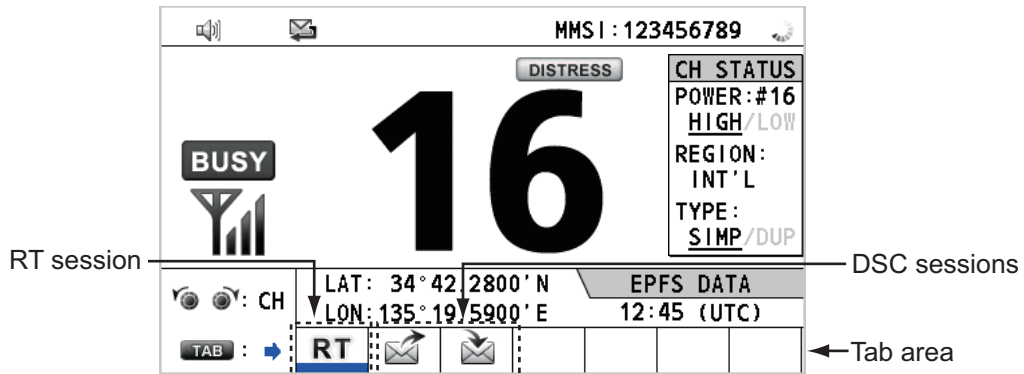

### How to finish a single session

#### RT session

1. Press the **TAB** key to select the RT icon in the tab area.
2. Rotate the **CHANNEL/ENTER** knob to select [QUIT] then push the knob.

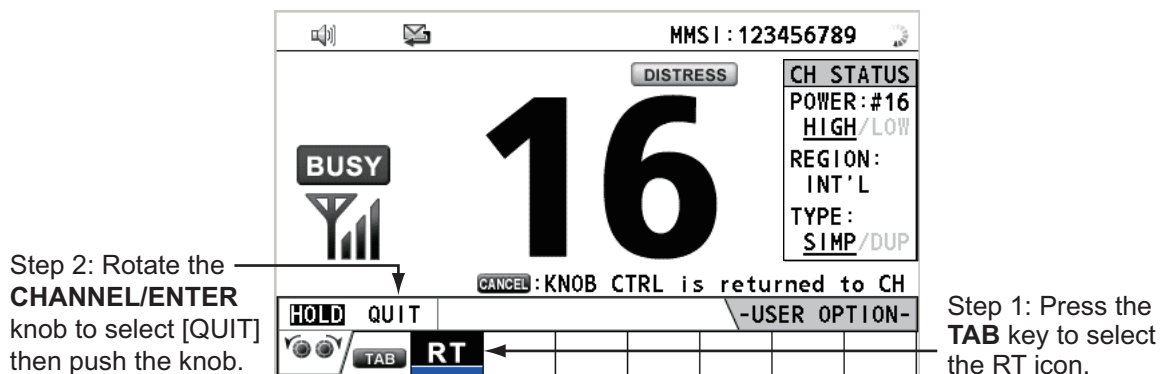

#### DSC session



The cursor is in the tab area when the DSC session starts. Rotate the **CHANNEL/ENTER** knob to select [QUIT] then push the knob.

Rotate the **CHANNEL/ENTER** knob to select [QUIT] then push the knob.

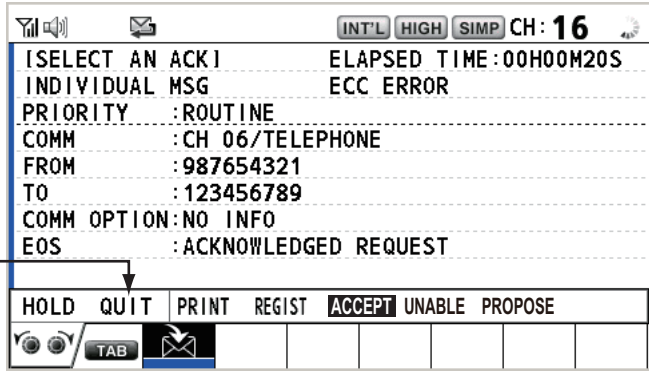

# 1. OPERATIONAL OVERVIEW

## How to start a new session

### When another session is active:

- When sending the distress alert, all sessions except the distress alert TX session automatically close then the distress alert TX session starts.
- When doing an RT session or sending a non-distress DSC message, the currently active session is put on hold then the RT session or non-distress DSC message TX session starts.
- When receiving a DSC message, its session is put on hold.

### When no other session is active:

- When sending the distress alert, all sessions except the distress alert TX session automatically close then the distress alert TX session starts.
- When sending a non-distress DSC message, its session becomes the active session.

## How to switch sessions

When one session is active and another message arrives, a new session for the received message does not start automatically. Only one session can be active. For example, when you are transmitting a DSC message and another message arrives, the indication [ACTIVE] appears to indicate the start of a new session.

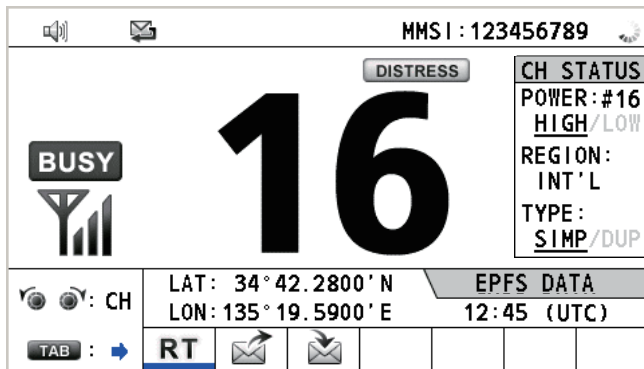

↓ Press the **TAB** key to move the cursor to the tab area.

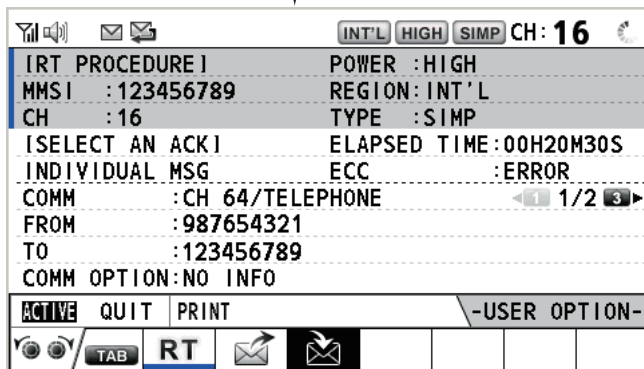

} Information for the session underlined in blue (RT in this case)

} Information for the session selected by cursor.

← User options area

← Tab area

↑ To select a session, press the **TAB** key. The cursor is here.  
 ↓ With [ACTIVE] selected, push the **CHANNEL/ENTER** knob to switch the active session. To switch the option for the session ([ACTIVE], [QUIT], [PRINT]), rotate the **CHANNEL/ENTER** knob.

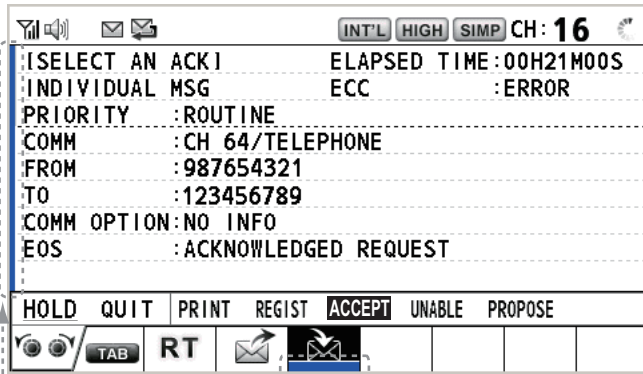



Only the screen for the selected session appears.

A blue line is displayed for an active session.

To finish this session, rotate the **CHANNEL/ENTER** knob to select [QUIT] then push the knob.

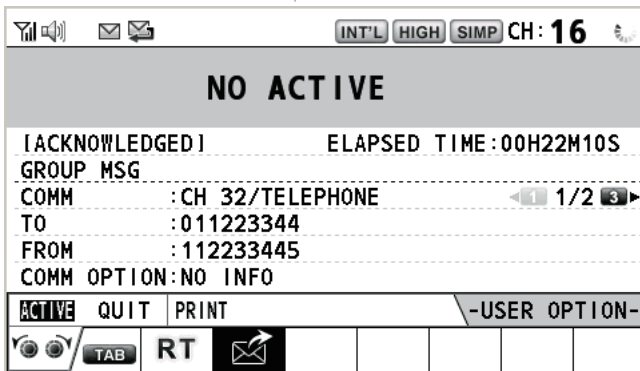
**Note:** When waiting for the ACK, that is, the session is in progress, the confirmation message appears. Rotate the **CHANNEL/ENTER** knob to select [Yes] or [No] then push the knob.



The  icon disappears.

**How to close a session when there are multiple sessions**

To manually close a session, select it with the **TAB** key. Rotate the **CHANNEL/ENTER** knob to select [QUIT] in the user options area then push the knob. The session icon disappears from the tab area.

When there is no operation for the time specified (see section 5.8), the inactive session is automatically closed.

**Processing when the number of sessions is maximum**

A maximum of seven sessions can be displayed in the tab area. If a seventh session starts, the message as shown in the right figure appears on the screen. Press the **CANCEL** key to close the message. Close a session to make space for the new session.

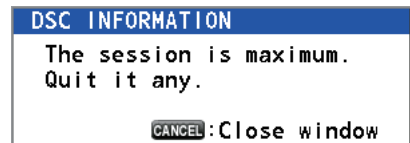

If the eighth session is for sending a distress alert, all sessions except that session automatically close, and the session starts.

If the eighth session is for receiving DSC message, the lowest-priority session automatically closes and the message as shown in the right figure appears. Press the **CANCEL** key to close the message.



## 1.15 Replay Function

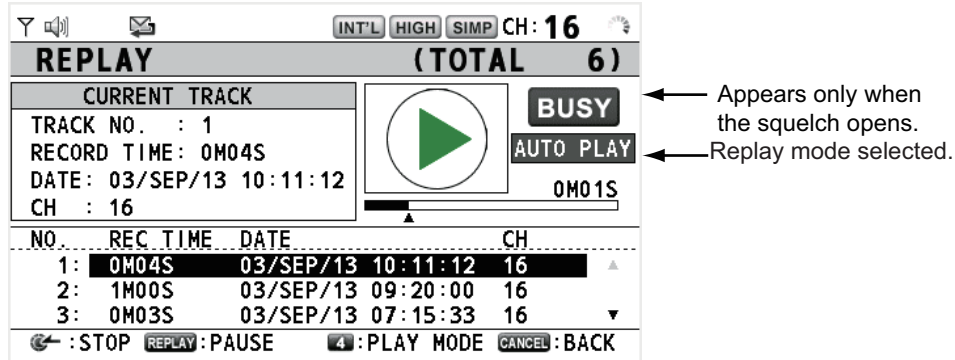

You can replay a recorded voice, which has been received recently, for a total of 120 seconds. The recorded voices are saved in this equipment with the channel information, and deleted when turning the power off. The channel information is also displayed on the replay screen.

To replay the recorded voice, press the **REPLAY** key.



The Replay mode is set with the **4** key. Press the **4** key to scroll through the three modes.

- **[AUTO PLAY]**: This is the default option. Auto play mode will replay all tracks in the order they are saved.
- **[REPEAT]**: Repeats only the current track.
- **No selection**: This mode stops the replay after the current track finishes.

When the replaying is finished, the indication  changes to .

To change the track number, rotate the **CHANNEL/ENTER** knob to select the track number desired then push the knob to replay the selected data.

To stop the replaying and close the screen, press the **CANCEL** key. Also, you can stop the replaying with the **CHANNEL/ENTER** knob. In this case, the [REPLAY] screen does not close.

**Note:** When the time limit (120 seconds) has passed, the recorded data is deleted per track in earliest to latest order.

# 2. DSC OVERVIEW

## 2.1 What is DSC?

DSC is an acronym meaning Digital Selective Calling. It is a digital distress and general calling system in the VHF band used by ships for transmitting distress alerts and general calls and by coast stations for transmitting the associated acknowledgments.

For DSC distress, safety and urgency callings in the VHF band, the channel is 70.

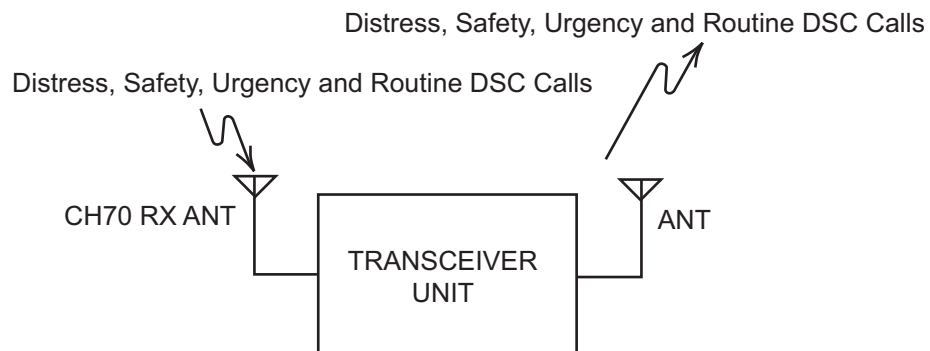

## 2.2 DSC Messages

DSC calls are roughly divided in two groups: distress messages and general (safety, urgency and routine) messages. Below are the types of DSC messages.

Call	Description
DISTRESS ALERT	Your ship sends distress message.
DISTRESS RELAY ALL	Your ship relays distress call to all ships.
DISTRESS RELAY INDIVIDUAL	Your ship relays distress call to a coast station or all ships.
MEDICAL MSG*	Inform areas that your ship is carrying medical supplies.
NEUTRAL MSG*	Inform areas that your ship is not a participant in armed conflict.
INDIVIDUAL MSG	Call to a specific address.
PSTN MSG	Call over Public Switched Telephone Network (PSTN).
TEST MSG	Send test signal to a station to test your station's functionality.
GROUP MSG	Call to a specific group.
ALL SHIPS MSG	Call to all ships.
POSITION MSG	Your ship requests position of other ships.
POLLING MSG	Confirm if your ship is within communicating range with other ships. (Receive and answer only)

\*SPECIAL MSG: To send these messages, set [SPECIAL MSG] to [ABLE]. See section 5.17.

**Contents of a DSC call**

- **Calling category**  
DISTRESS: DISTRESS ALERT, DISTRESS RELAY ALL, DISTRESS RELAY INDIVIDUAL, DISTRESS RELAY AREA (Received only), DISTRESS RELAY GROUP (Received only), DISTRESS ACK  
GENERAL: MEDICAL MSG, NEUTRAL MSG, INDIVIDUAL MSG, PSTN MSG, TEST MSG, GROUP MSG, ALL SHIPS MSG, POSITION MSG, POLLING MSG
- **Station ID (MMSI)**  
 Your ship ID and sending station ID. Coast station ID begins with 00; Group ID begins with 0.
- **Priority**  
Distress: Grave and imminent danger and request immediate assistance.  
Urgency: A calling station has a very urgent call to transmit concerning safety of ship, aircraft or other vehicle or safety of person.  
Safety: A station is about to transmit a call containing an important navigational or meteorological warning.  
Routine: General calling
- **Communication mode**  
TELEPHONE: Telephone (16K0G3E(F3E)) by VHF radiotelephone
- **Communication channel**  
 Working frequency channel used to call by telephone. The sending station may have the receiving station (ship or coast station) assign the frequency channel to use.
- **Position**  
 Position can be automatically or manually set.
- **End code**  
 The end of a DSC call is indicated with "RQ" (acknowledgment required), "BQ" (acknowledgment) or "EOS" (no acknowledgment required).

## 2.3 Audio Alarms

When you receive a distress alert or general call addressed to your ship, the audio and visual alarms are released. The audio alarm can be silenced with the **CANCEL** key.

Alarm	When	Frequency (interval)
Count alarm	Counting down the time remaining before the distress alert is transmitted.	2000 Hz (500 ms) → silent (500 ms); three times
Distress RX alarm	The following sessions are received: distress alert, relay individual, relay group, relay area, or relay all.	2200 Hz (250 ms) → 1300 Hz (250 ms); repetition
Distress TX alarm	Sending or resending the distress alert.	2200 Hz (2000 ms); once
Distress ACK alarm	The following sessions are received or received then acknowledged: distress ACK, distress ACK (cancel ACK), relay individual ACK, relay group ACK, or relay all ACK.	2200 Hz (500 ms) → 1300 Hz (500 ms); repetition
Urgency alarm	The following urgency sessions are received: all ships, neutral, medical, or individual.	2200 Hz (250 ms) → silent (250 ms); repetition

Alarm	When	Frequency (interval)
Urgency ACK alarm	The sessions for urgency individual ACK are received then acknowledged. The sessions for delayed ACK are received.	2200 Hz (500 ms) → silent (500 ms); repetition
Ordinary alarm	The following sessions are received: <ul style="list-style-type: none"> <li>• Safety: all ships, individual, position, or test.</li> <li>• Routine: individual, group, polling, or PSTN.</li> </ul>	The following set is repeated: 750 Hz (50 ms) and 650 Hz (50 ms); ten times → silent (2000 ms); once
Ordinary ACK alarm	The following sessions are received then acknowledged: <ul style="list-style-type: none"> <li>• Safety: individual ACK, position ACK, test ACK.</li> <li>• Routine: individual ACK.</li> </ul> The sessions for delayed ACK are received.	The following set is repeated: 750 Hz (50 ms) and 650 Hz (50 ms); ten times → silent (2000 ms); once
Self terminating alarm	<ul style="list-style-type: none"> <li>• There are the related sessions for call messages.</li> <li>• The related sessions for ACK messages were already acknowledged.</li> <li>• Sending the individual unable auto ACK or PSTN unable auto ACK.</li> <li>• The following sessions are received: relay area (duplicate), relay all (duplicate), or PSTN end of call ACK.</li> </ul>	1300 Hz (100 ms) → silent (300 ms) → 1300 Hz (100 ms) → silent (50 ms) → 1300 Hz (100 ms)

## 2.4 Description of Call Screens

This section provides the information necessary for interpreting the receive and send call screens.

### 2.4.1 RX calls

Below are sample distress relay and individual RX call screens. The contents of other types of RX calls are similar to that of the individual call.

#### Distress relay

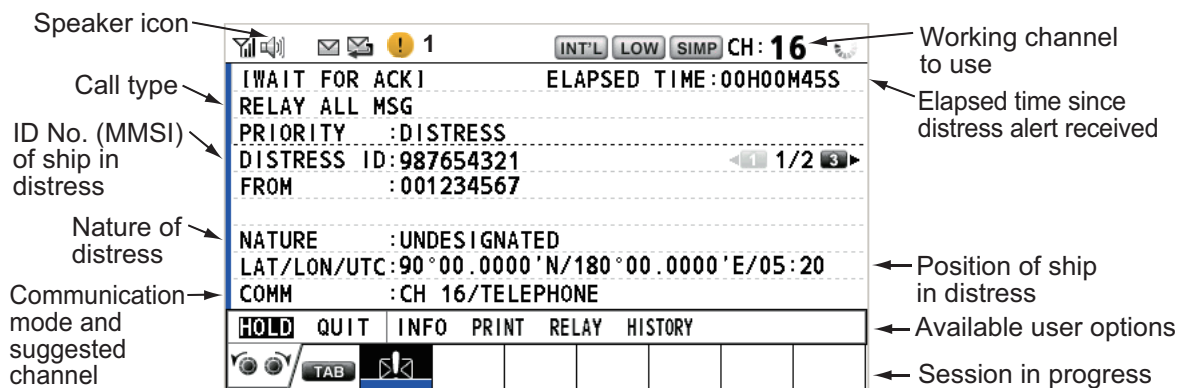

## 2. DSC OVERVIEW

### Individual RX call

The screenshot shows a DSC receiving screen for an individual message. The top status bar includes a speaker icon, a message icon, a '1' indicator, and channel information: INT'L HIGH SIMP CH: 16. The main display area contains the following text:

```

ISELECT AN ACK I      ELAPSED TIME:00H00M45S
INDIVIDUAL MSG      ECC      :ERROR
PRIORITY      :ROUTINE
COMM      :CH 64/TELEPHONE
FROM      :112233445
TO      :311223344
COMM OPTION:NO INFO
EOS      :ACKNOWLEDGED REQUEST
  
```

Annotations on the left side point to:

- Speaker icon
- Call type
- Communication mode
- ID No. (MMSI) of ship sending this message

Annotations on the right side point to:

- Working channel to use
- Elapsed time since call received
- Appears when ECC is NG.
- Available user options
- Session in progress

At the bottom, there is a menu bar with options: HOLD, QUIT, PRINT, REGIST, ACCEPT, UNABLE, PROPOSE. Below this are several icons, including a 'TAB' button.

The characters "\*", "-" appear on the DSC receiving screen in the following conditions:

- "\*" indicates a corrupt character in received data.
- "-" indicates no info for position data after decimal point.

Examples:

- 1) When there is no position data after decimal point, the indication is "LAT: 12°34'N".
- 2) When there is position data after decimal point, the indication is "LAT: 12°34,5678'N".
- 3) When the position data after decimal point is no info, the indication is "LAT: 12°34,----'N".

### 2.4.2 TX calls

Below are sample distress alert and individual TX call screens. The contents of other types of TX calls are similar to that of the individual call.

#### Distress alert

The screenshot shows a 'COMPOSE MESSAGE' screen for a distress alert. The top status bar includes a speaker icon, a message icon, and channel information: INT'L HIGH SIMP CH: 16. The main display area contains the following text:

```

COMPOSE MESSAGE
MSG TYPE      :DISTRESS ALERT
DISTRESS ID  :123456789
NATURE       :UNDESIGNATED
LAT          :34°42.2800'N
LON/UTC      :135°19.5900'E / 12:34
COMM MODE    :TELEPHONE
PRESS DISTRESS BUTTON
TO SEND DISTRESS ALERT.
CANCEL:BACK
  
```

Annotations on the right side point to:

- Nature of Distress
- Position of ship in distress (your ship) and time of distress position
- Communication mode



Individual TX call

The screenshot shows a 'COMPOSE MESSAGE' screen with the following fields and values:

Field	Value
MSG TYPE	INDIVIDUAL MSG
TO	123456789
PRIORITY	ROUTINE
COMM MODE	TELEPHONE
COMM CH	06

Annotations on the left side:

- ID No. of station where message is to be sent → TO
- Communication channel → COMM CH

Annotations on the right side:

- Message type (Individual) → MSG TYPE
- Priority (Routine, Safety, Urgency) → PRIORITY
- Communication mode → COMM MODE

Buttons at the bottom: CANCEL · BACK      GO TO CALL

## 2. DSC OVERVIEW

This page is intentionally left blank.

# 3. DSC DISTRESS OPERATIONS

## Distress operation overview

1. Press the **DISTRESS** key.
2. Wait for the distress alert acknowledgment.
3. Communicate with the coast station.

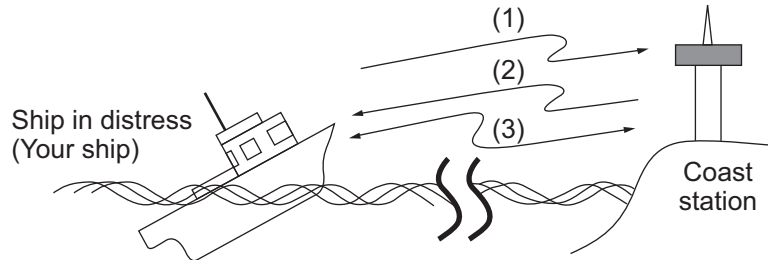

- (1) Ship in distress sends Distress Alert.
- (2) Coast station sends distress acknowledgement (DIST ACK).
- (3) Voice communication between ship in distress and coast station.

## 3.1 How to Send a Distress Alert

GMDSS ships carry a DSC terminal with which to transmit the distress alert in the event of a life-endangering situation. A coast station receives the distress alert and sends the distress alert acknowledge call to the ship in distress. Then, voice communication between the ship in distress and coast station begins. Transmission of the distress alert and receiving of the distress alert acknowledgment are completely automatic - simply press the **DISTRESS** key to initiate the sequence.

**Note:** If the session for sending a distress alert starts when there are maximum seven sessions in the tab area, all sessions except that session automatically close.

### 3.1.1 How to send a distress alert by **DISTRESS** key with distress information not edited

1. Open the **DISTRESS** key cover then press and hold the **DISTRESS** key for four seconds.

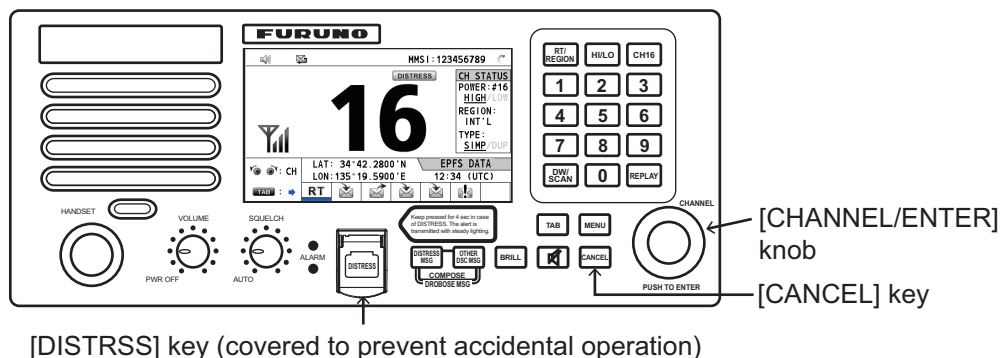

### 3. DSC DISTRESS OPERATIONS

The audio alarm sounds while pressing the key, and the key flashes in red. The countdown message appears on the screen while pressing the **DISTRESS** key (3s → 2s → 1s → 0s).

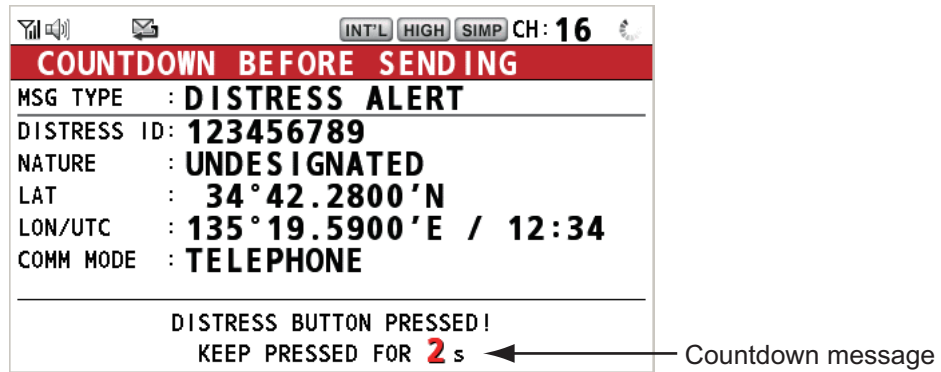

When the countdown shows 0s, the distress alert is sent. The audio alarm sounds for two seconds and the message "Sending DISTRESS ALERT." appears.

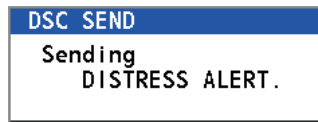

The **DISTRESS** key lights in red and only the icon for DISTRESS transmission (📞) is displayed in the tab area.

After the distress alert has been sent, the screen changes as below. Wait to receive the distress acknowledge call from a coast station. The elapsed time since transmission is displayed. At this time, the icons for other DSC received messages except the distress alert acknowledge call are not displayed. You can only confirm them in the log.

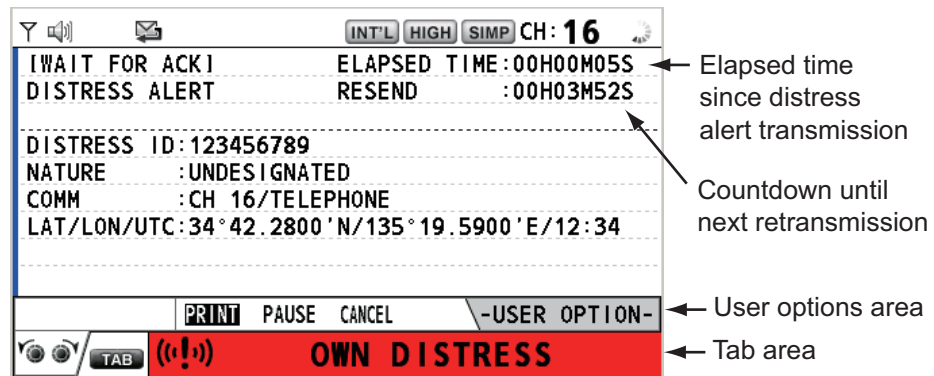

**Note:** If you do not receive the distress alert acknowledge call, the equipment automatically re-transmits the distress alert after 3 min 30 seconds to 4 min 30 seconds. The equipment then awaits the distress alert acknowledge call. This is repeated until the distress alert is acknowledged.

You can temporarily stop the countdown for next retransmission by selecting [PAUSE] in the user options area. The [PAUSE] indication changes to [START] and [PAUSE] is displayed instead of the countdown indication. To restart, select [START]. The countdown restarts and the [START] indication changes to [PAUSE].

Also, you can re-send the distress alert manually by pressing and holding the **DISTRESS** key for four seconds.

When the distress acknowledge call is received, the audio alarm sounds, the LED flashes in red, and the icon for DISTRESS transmission ((!)) appears. The screen changes as below.

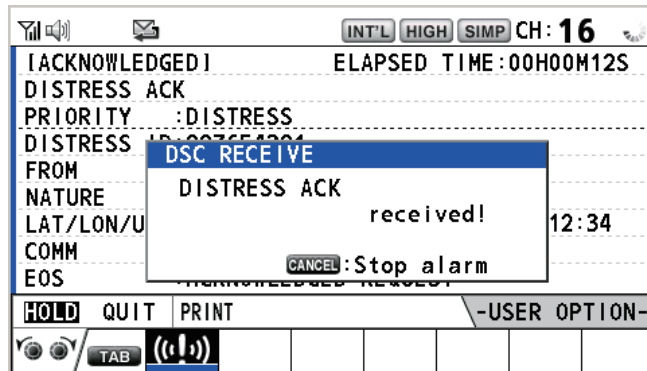

2. Press the **CANCEL** key to silence the audio alarm. Then, the LED stops flashing, and the pop-up message disappears.

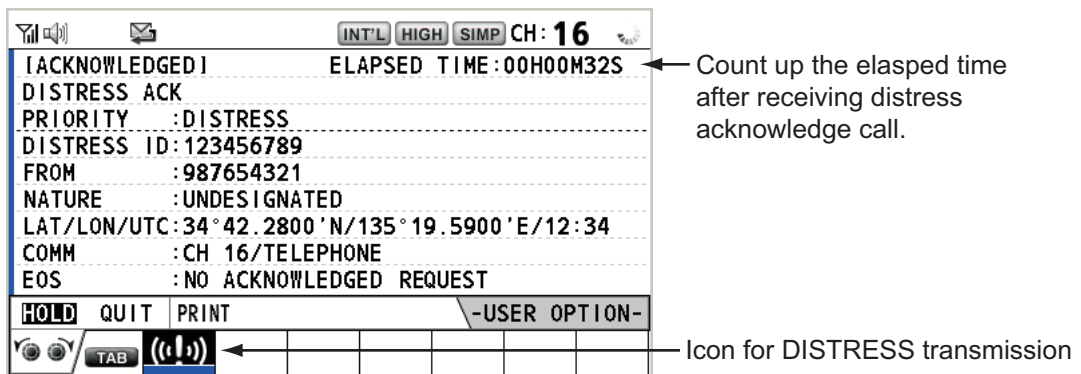

3. Communicate with the coast station via radiotelephone, following the instructions below.
  - a) Say “MAYDAY” three times.
  - b) Say “This is...” name of your ship and call sign three times.
  - c) Give nature of distress and assistance needed.
  - d) Give description of your ship (type, color, number of persons onboard, etc.).

### 3.1.2 How to send a distress alert by DISTRESS key with distress information edited

If you have a time to prepare the distress information, send the distress alert as follows:

1. Press the **DISTRESS MSG** key to display the following screen.

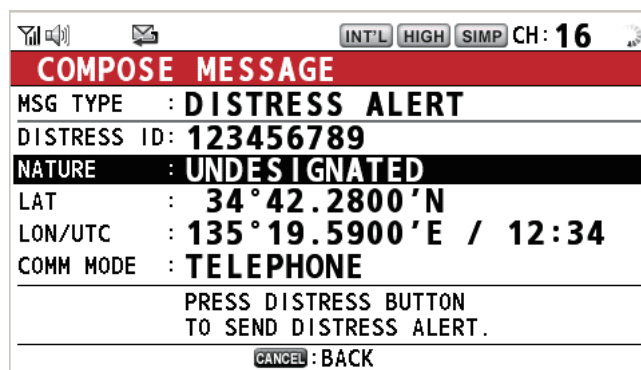

### 3. DSC DISTRESS OPERATIONS

2. With [NATURE] selected, push the **CHANNEL/ENTER** knob.
3. Rotate the **CHANNEL/ENTER** knob to select the nature of distress, among the following 11 selections, then push the knob.
  - UNDESIGNATED
  - FIRE
  - FLOODING
  - COLLISION
  - GROUNDING
  - LISTING
  - SINKING
  - DISABLED&ADR(IFT)
  - ABANDONING
  - PIRACY
  - MAN OVERBOARD

4. With [LAT] and [LON/UTC] selected, push the **CHANNEL/ENTER** knob.

[EPFS]: The position information from EPFS is automatically shown.

[MANUAL]: Input your position manually.

[NO INFO]: No information.



5. Rotate the **CHANNEL/ENTER** knob to select [EPFS], [MANUAL] or [NO INFO] then push the knob. For [MANUAL], go to step 6. For others, go to step 7.
6. Use the numeric keys to enter latitude, longitude and UTC time. (If necessary, switch coordinates: **1** key to switch to North (East for longitude); **2** key to switch to South (West for longitude).) Push the **CHANNEL/ENTER** knob.

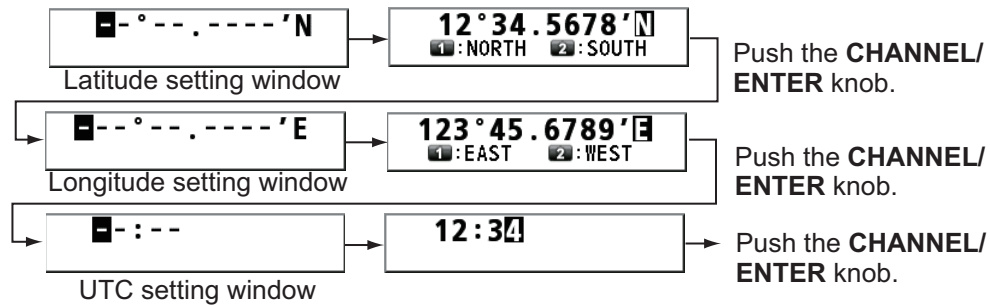

7. Press and hold the **DISTRESS** key for four seconds to send the distress alert. The audio alarm sounds while pressing the key, and the key flashes in red. The countdown message appears on the screen while pressing the **DISTRESS** key (3s → 2s → 1s → 0s) (refer to the illustration at step 1 in subsection 3.1.1). When the countdown shows 0s, the distress alert is sent. The audio alarm sounds for two seconds and the message "Sending DISTRESS ALERT." appears.
8. When the distress acknowledge call is received, use the telephone to communicate with the coast station referring to step 3 in subsection 3.1.1.

## 3.2 How to Receive a Distress Alert

When you receive a distress alert from a ship in distress, the audio alarm sounds and the LED flashes in red. The icon for DISTRESS receiving (📞🚨) appears in the tab area and the pop-up message "DISTRESS ALERT message received! [CANCEL]: Stop alarm" appears on the screen.

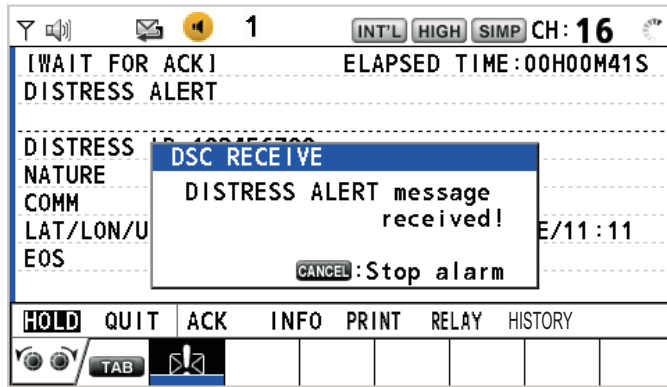

Press the **CANCEL** key to silence the audio alarm. Wait for the distress acknowledge call from a coast station. If you do not receive the distress acknowledge call from a coast station, which usually takes about five minutes from the time of receiving a distress alert, follow the flow charts in this section to determine your action.

**Note:** An asterisk (\*) appearing in a distress alert message indicates an error at the asterisk's location.

In no case is a ship permitted to transmit a DSC distress relay call upon receipt of a DSC distress alert on VHF channel 70.

**Flow chart for determining if you should/should not transmit a distress acknowledge call**

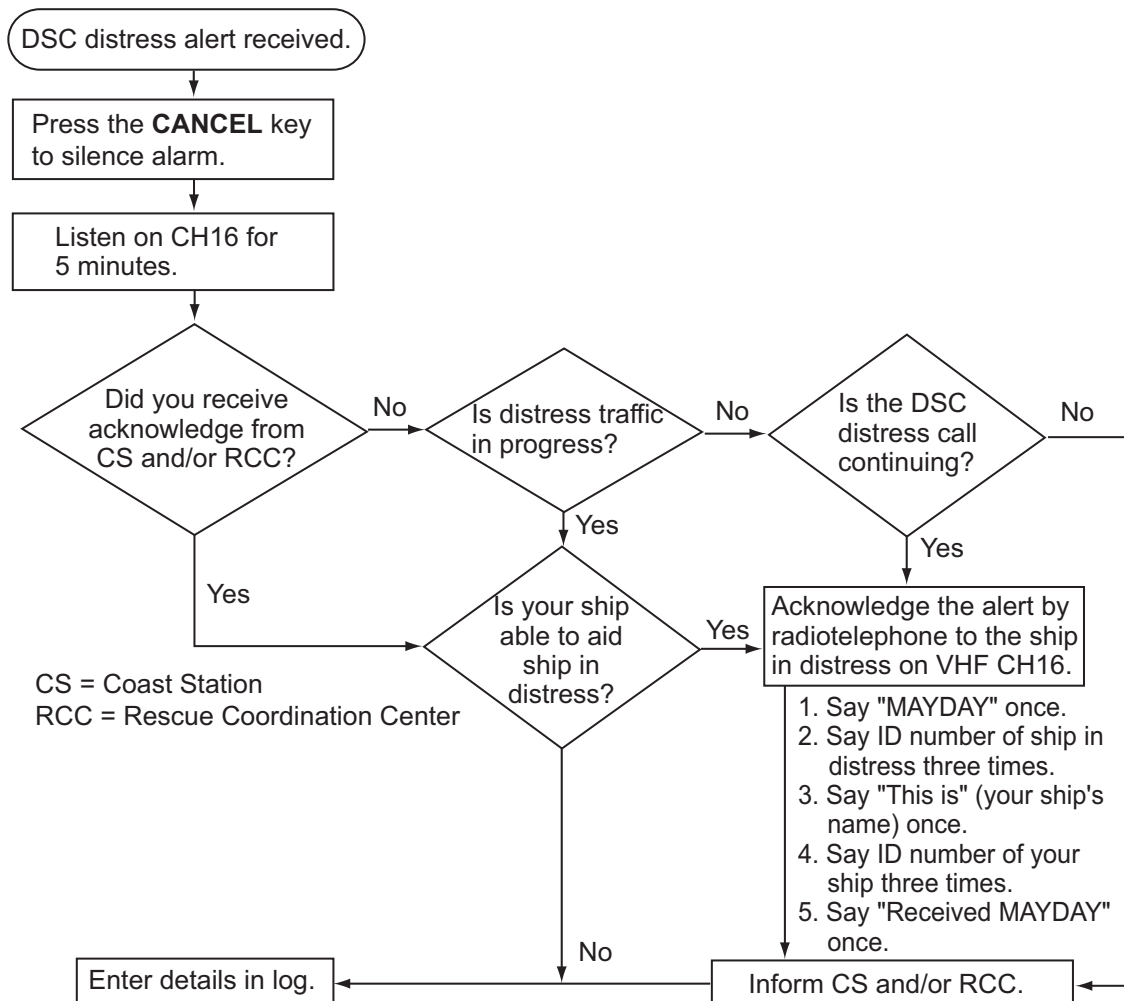

**How to transmit a distress acknowledge call over CH16**

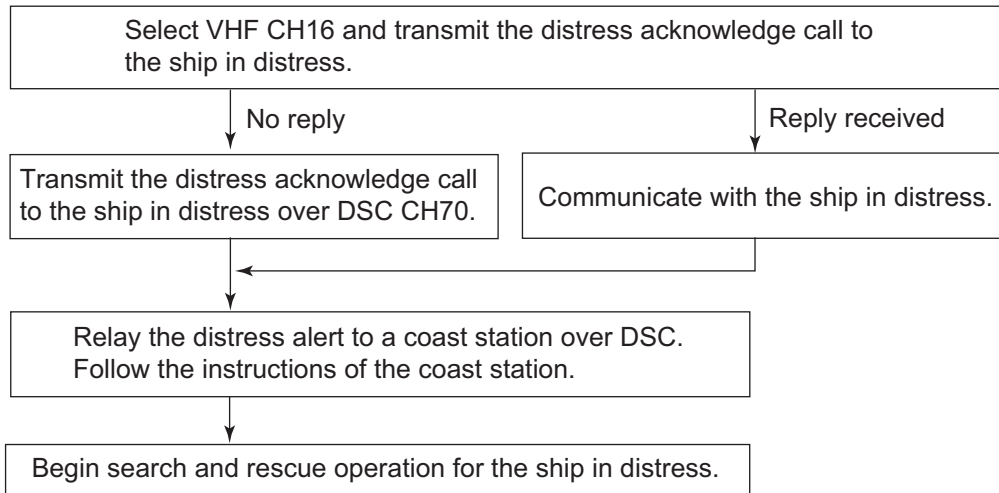

**Procedure when in area A1**

When you receive a distress alert from a ship in distress, the audio alarm sounds and the LED flashes in red. The icon for DISTRESS receiving (📶🚨) appears in the tab area and the pop-up message "DISTRESS ALERT message received! [CANCEL]: Stop alarm" appears on the screen.

Press the **CANCEL** key to silence the audio alarm. Wait for the distress acknowledge call from a coast station. If you do not receive the distress acknowledge call from a coast station, which usually takes about five minutes from the time of receiving a distress alert, follow the flow charts on page 3-5.

If further DSC alerts are received from the same source and the ship in distress is beyond doubt in the vicinity, a DSC acknowledgment may, after consultation with a Rescue Coordination Center (RCC) or Coast Station, be sent to terminate the distress call.

**Note 1:** An asterisk (\*) appearing in a distress alert message indicates an error at the asterisk's location.

**Note 2:** Do not send the distress acknowledge call in response to receipt of distress alert having the nature of distress as "EPIRB emission".

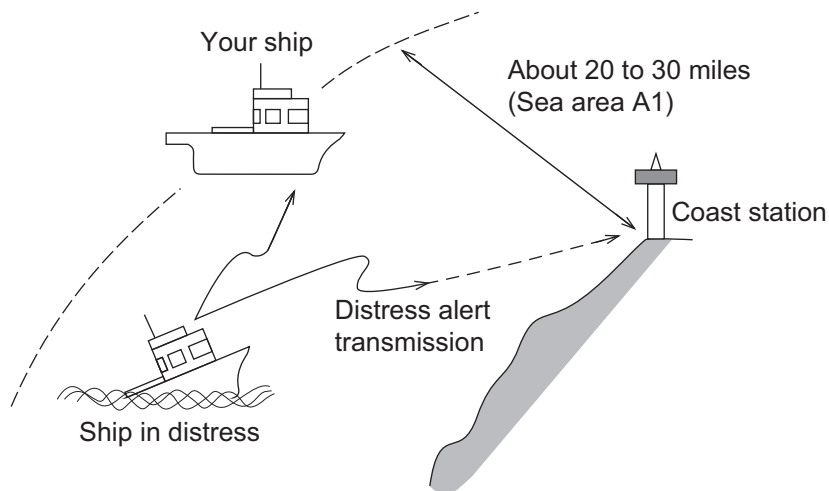



**How to send a distress acknowledge call**

When you receive a distress alert from a ship in distress, the audio alarm sounds and the LED flashes in red. If your ship meets the requirements necessary to transmit the distress acknowledge call, do the following:

1. Press the **CANCEL** key to silence the audio alarm and stop the flashing of the LED.

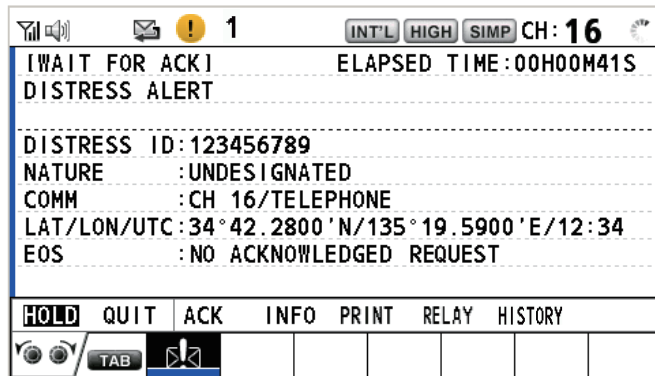

2. Rotate the **CHANNEL/ENTER** knob to select [ACK] in the user options area then push the knob. The following message appears on the screen.

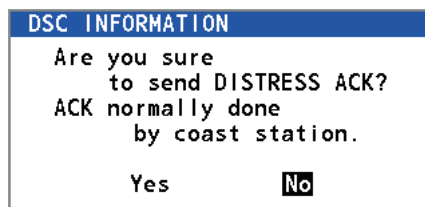

3. If you do not receive the distress acknowledge call from a coast station within five minutes and your ship meets requirements for transmitting the distress acknowledge call, rotate the **CHANNEL/ENTER** knob to select [Yes] then push the knob to send the distress acknowledge call to the ship in distress. The screen changes as below.

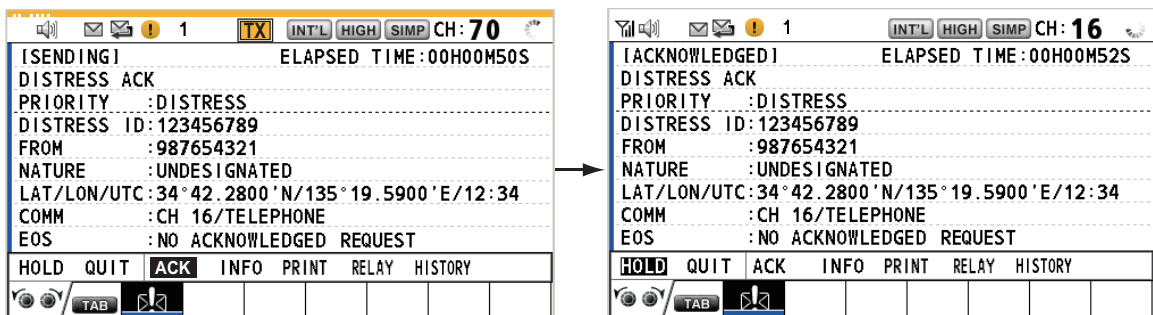

Begin search and rescue operations for the ship in distress, communicating with the ship over CH16 (automatically set). Relay distress alert to a coast station by DSC following the instruction in the next section. Finally, follow the instructions of the coast station.

**How to send a distress relay to a coast station**

You can send the distress relay to a coast station from the receiving screen for the distress alert.

1. Rotate the **CHANNEL/ENTER** knob to select [RELAY] in the user options area then push the knob. If three minutes have not passed from the time the distress alert was received, the following message appears.

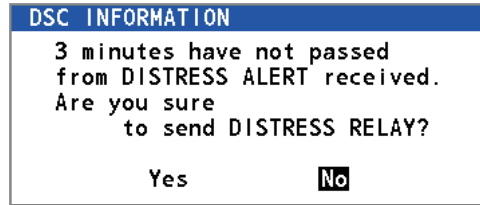

2. Rotate the **CHANNEL/ENTER** knob to select [Yes] then push the knob to open the composing screen for the distress relay individual.

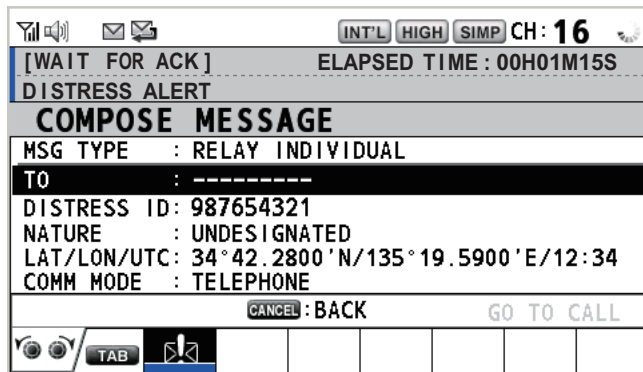

3. With [TO] selected, push the **CHANNEL/ENTER** knob.
4. Rotate the **CHANNEL/ENTER** knob to select [DIRECT INPUT], [ADDRESS BOOK DATA] or [AIS TARGET DATA] then push the knob.  
 [DIRECT INPUT]: Enter the MMSI, where to send the distress relay, with the numeric keys then push the **CHANNEL/ENTER** knob.  
 [ADDRESS BOOK DATA]: Select an MMSI from the [ADDRESS BOOK] (see section 5.13) then push the **CHANNEL/ENTER** knob.  
 [AIS TARGET DATA]: Select an MMSI from the [AIS TARGET LIST] then push the **CHANNEL/ENTER** knob.

AIS target list

If an AIS transponder is connected to the radiotelephone, you can select a MMSI from the [AIS TARGET LIST].

5. With [GO TO CALL] selected, push the **CHANNEL/ENTER** knob. The distress relay is transmitted. After transmitting, the WAIT FOR ACK screen appears. The elapsed time since transmitting is displayed.

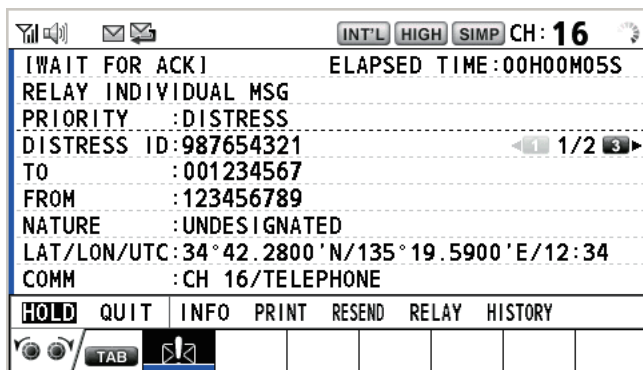

**How to send a distress relay all**

You can send the distress relay all from the receiving screen for the distress alert.

1. Rotate the **CHANNEL/ENTER** knob to select [RELAY] in the user options area then push the knob. If three minutes have not passed from the distress alert received, the following message appears.

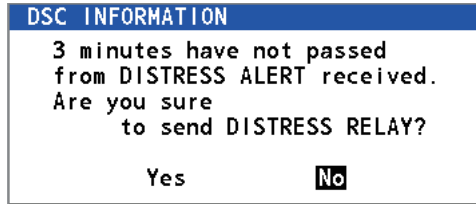

2. Rotate the **CHANNEL/ENTER** knob to select [Yes] then push the knob to open the composing screen for the distress relay individual.

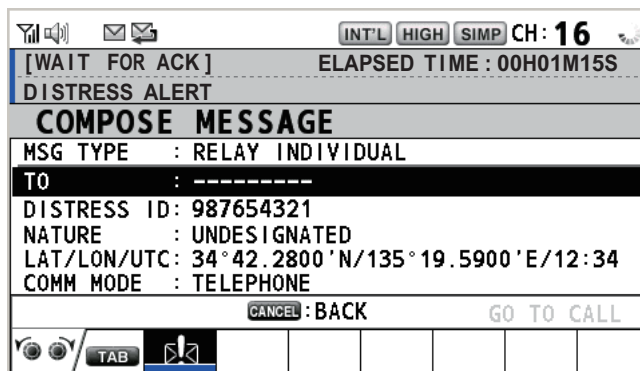

3. Rotate the **CHANNEL/ENTER** knob to select [MSG TYPE] then push the knob.
4. Rotate the **CHANNEL/ENTER** knob to select [RELAY ALL] then push the knob. The following message appears.

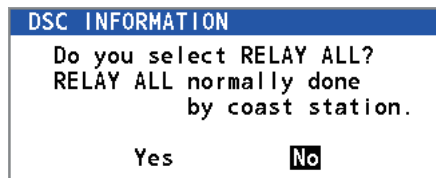

5. Rotate the **CHANNEL/ENTER** knob to select [Yes] then push the knob.
6. With [GO TO CALL] selected, push the **CHANNEL/ENTER** knob. The distress relay is transmitted to all ships.

### 3.3 How to Send a Distress Relay on Behalf of a Ship in Distress

#### 3.3.1 How to send a distress relay to a coast station

You can send the distress relay to a coast station on behalf of a ship in distress in the following cases:

- You are near the ship in distress and the ship in distress cannot transmit the distress alert.
- When the master or person responsible for your ship considers that further assistance is necessary.

**Note:** Do not use the **DISTRESS** key to relay distress.

1. Press the **DISTRESS MSG** key and the **OTHER DSC MSG** key simultaneously to open the composing screen for the distress relay individual.

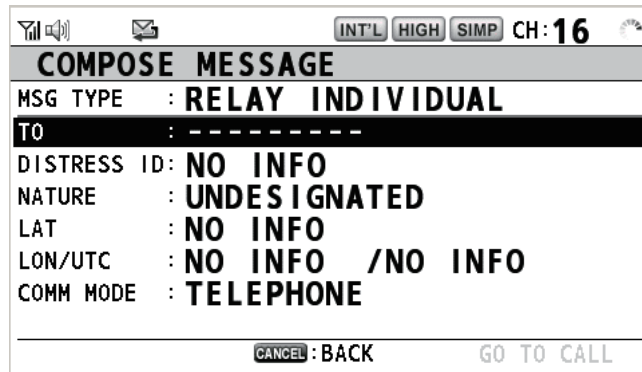

2. With [TO] selected, push the **CHANNEL/ENTER** knob.
3. Rotate the **CHANNEL/ENTER** knob to select [DIRECT INPUT], [ADDRESS BOOK DATA] or [AIS TARGET DATA] then push the knob.  
 [DIRECT INPUT]: Enter the MMSI, where to send the distress relay, with the numeric keys then push the **CHANNEL/ENTER** knob.  
 [ADDRESS BOOK DATA]: Select an MMSI from the [ADDRESS BOOK] (see section 5.13) then push the **CHANNEL/ENTER** knob.  
 [AIS TARGET DATA]: Select an MMSI from the [AIS TARGET LIST] then push the **CHANNEL/ENTER** knob.
4. With [DISTRESS ID] selected, push the **CHANNEL/ENTER** knob.



5. Rotate the **CHANNEL/ENTER** knob to select [DIRECT INPUT] or [NO INFO] then push the knob. For [DIRECT INPUT], go to step 6. For [NO INFO], go to step 7.
6. Enter the ID (MMSI) of the ship in distress with the numeric keys then push the **CHANNEL/ENTER** knob.
7. With [NATURE] selected, push the **CHANNEL/ENTER** knob.
8. Rotate the **CHANNEL/ENTER** knob to select nature of distress then push the knob.
9. With [LAT] and [LON/UTC] selected, push the **CHANNEL/ENTER** knob.

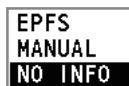

10. Rotate the **CHANNEL/ENTER** knob to select [EPFS], [MANUAL] or [NO INFO] then push the knob. For [MANUAL], go to step 11. For others, go to step 12.
11. Use the numeric keys to enter latitude and longitude of the ship in distress. (If necessary, switch coordinates: **1** key to switch to North (East); **2** key to switch to South (West).) Push the **CHANNEL/ENTER** knob. Also, enter the UTC time then push the **CHANNEL/ENTER** knob.
12. With [GO TO CALL] selected, push the **CHANNEL/ENTER** knob. The distress relay is transmitted. After transmitting, the WAIT FOR ACK screen appears. The elapsed time since transmitting is displayed.

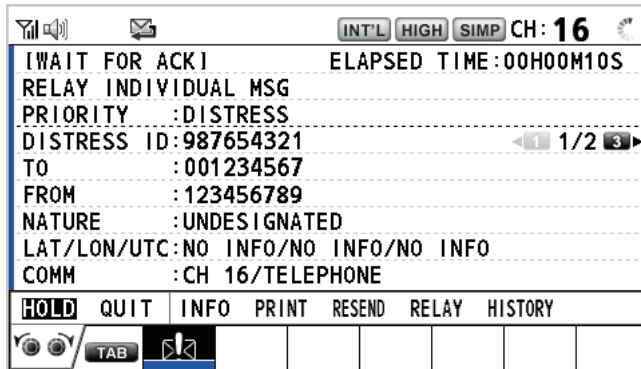

When you receive the distress relay individual acknowledgment from the coast station, the audio alarm sounds and the pop-up message "RELAY INDIVIDUAL ACK received! [CANCEL]: Stop alarm" appears.



Press the **CANCEL** key to silence the alarm and erase the pop-up message. Communicate with the coast station by telephone. To close the distress receiving session, select [QUIT] in the user options area then push the **CHANNEL/ENTER** knob.

### 3.3.2 How to send a distress relay to all ships

If a coast station directs you to send a distress relay to all ships in your area, follow the procedure below. Do not transmit a distress relay unless directed to do so by a coast station.

1. Press the **DISTRESS MSG** key and the **OTHER DSC MSG** key simultaneously to open the composing screen for the distress relay individual.

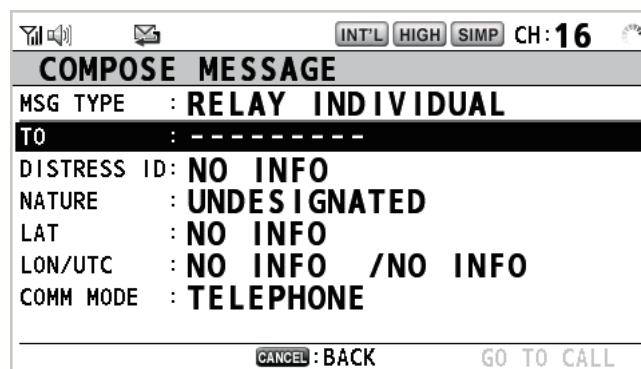

### 3. DSC DISTRESS OPERATIONS

2. Rotate the **CHANNEL/ENTER** knob to select [MSG TYPE] then push the knob.



RELAY INDIVIDUAL  
RELAY ALL

3. Rotate the **CHANNEL/ENTER** knob to select [RELAY ALL] then push the knob. The following message appears.

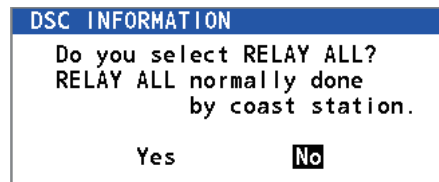

DSC INFORMATION  
Do you select RELAY ALL?  
RELAY ALL normally done  
by coast station.  
Yes      **No**

4. Rotate the **CHANNEL/ENTER** knob to select [Yes] then push the knob.
5. With [DISTRESS ID] selected, push the **CHANNEL/ENTER** knob.
6. Rotate the **CHANNEL/ENTER** knob to select [DIRECT INPUT] or [NO INFO] then push the knob. For [DIRECT INPUT], go to step 7. For [NO INFO], go to step 8.
7. Enter the ID (MMSI) of the ship in distress with the numeric keys then push the **CHANNEL/ENTER** knob.
8. With [NATURE] selected, push the **CHANNEL/ENTER** knob.
9. Rotate the **CHANNEL/ENTER** knob to select the nature of distress then push the knob.
10. With [LAT] and [LON/UTC] selected, push the **CHANNEL/ENTER** knob.



EPFS  
MANUAL  
NO INFO

11. Rotate the **CHANNEL/ENTER** knob to select [EPFS], [MANUAL] or [NO INFO] then push the knob. For [MANUAL], go to step 12. For others, go to step 13.
12. Use the numeric keys to enter latitude and longitude of the ship in distress. (If necessary, switch coordinates: **1** key to switch to North (East); **2** key to switch to South (West).) Push the **CHANNEL/ENTER** knob. Also, enter the UTC time then push the **CHANNEL/ENTER** knob.
13. With [GO TO CALL] selected, push the **CHANNEL/ENTER** knob. The distress relay is transmitted to all ships.

## 3.4 How to Receive a Distress Relay

There are three types of distress relay messages: distress relay for all ships, distress relay area and distress relay from coast station. When you receive a distress relay message, continue monitoring CH16. The audio alarm sounds and the LED flashes in red. The icon (📢) appears in the tab area and the applicable pop-up message appears on the screen.

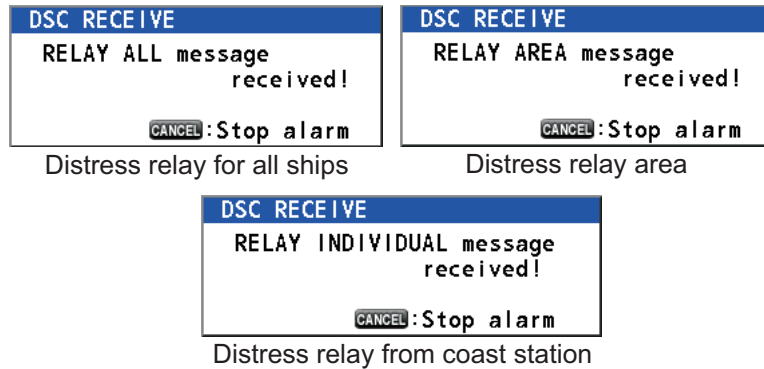

1. Press the **CANCEL** key to silence the audio alarm, stop the flashing of the LED and erase the pop-up message.
2. Watch CH16.

## 3.5 How to Cancel the Distress Alert

You can cancel the distress alert while waiting for its acknowledgment as follows.

1. Rotate the **CHANNEL/ENTER** knob to select [CANCEL] in the user options area then push the knob.

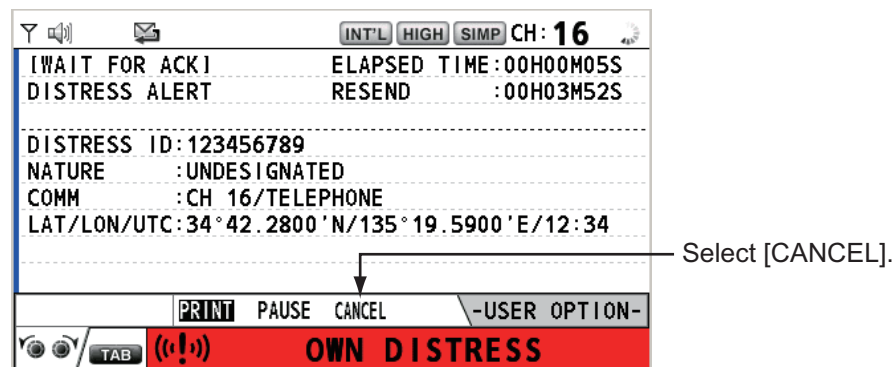

The following message appears on the screen.

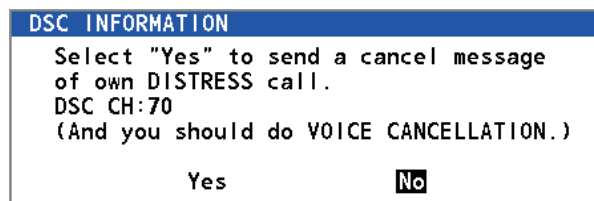

### 3. DSC DISTRESS OPERATIONS

2. Rotate the **CHANNEL/ENTER** knob to select [Yes] then push the knob to cancel the distress alert over CH70. After transmitting the distress cancel call, the following message appears on the screen.

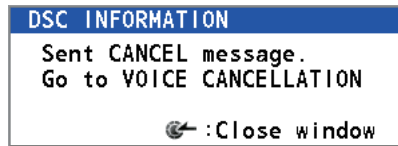

3. Push the **CHANNEL/ENTER** knob to erase the message. The following message appears on the screen.

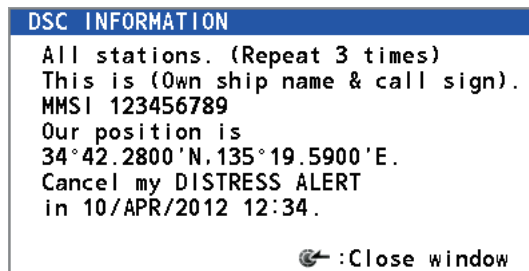

4. Communicate with all ships via radiotelephone referring to the message shown at step 3.
5. Push the **CHANNEL/ENTER** knob. The following message appears on the screen.

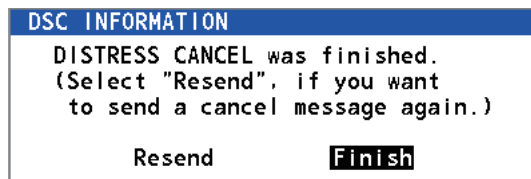

6. With [Finish] selected, push the **CHANNEL/ENTER** knob.

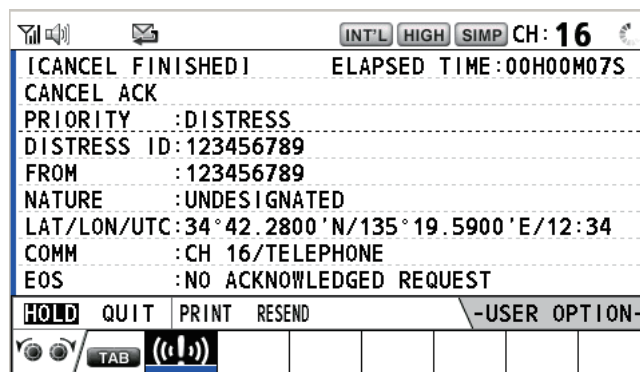

7. Rotate the **CHANNEL/ENTER** knob to select [QUIT] in the user options area then push the knob. The RT screen appears.



## 3.6 How to Handle Messages From the MOB Device

The system can receive DSC distress messages from the MOB device attached to life-jackets. The device outputs a distress message in two modes, based on acknowledged status. The methods and escalation are listed in the table below.

Mode	Alert Priority	Escalation
CLOSED (Transmitted to Own Ship and consort vessels)	DISTRESS RELAY	If unacknowledged, escalated to OPEN mode and DISTRESS ALERT level.
OPEN (Transmitted to all vessels and coastal stations)	DISTRESS ALERT	None

**Note 1:** A group MMSI must be registered in order to receive DISTRESS RELAY GROUP messages (see section 5.13.2).

**Note 2:** Vessels with AIS systems show the MOB device with coordinates.

**Note 3:** The MOB device operation varies depending on the manufacturer. Refer to your MOB device manual for operational instructions.

**Note 4:** Depending on the MOB device, the initial distress message transmission mode may be either CLOSED or OPEN.

The MOB device transmits the DSC DISTRESS RELAY message in the CLOSED mode at five minute intervals, three times. Vessels receiving this message should acknowledge as soon as possible and organize rescue operations.

**Note:** DSC acknowledgment messages should only be sent when the Master or person in charge of the recovery vessel considers it prudent to do so.

If the DISTRESS RELAY message is not acknowledged within 12 minutes from the initial message transmission, the DSC message is escalated to DISTRESS ALERT and the output mode changes to OPEN.

At this point, the DISTRESS ALERT message is transmitted at five minute intervals again, three times. Vessels receiving this message should acknowledge as soon as possible and organize rescue operations.

**Note:** DSC acknowledgments to open loop MOB device alerts are normally only sent by coast stations, or under direction of a coast station. However, the recovery vessel may send a DSC acknowledgment message if the person in the water has been recovered.

If the DISTRESS ALERT message is not acknowledged within 30 minutes of the initial message transmission, the device switches to battery-saving mode. Battery-saving mode transmits the DISTRESS ALERT message at 10 minute intervals, comprised of 5 minutes monitor mode and 5 minutes sleep mode.

The alert cannot be acknowledged if the device is in sleep mode.

The following figures provide a graphic representation of the cycles described above.

### 3. DSC DISTRESS OPERATIONS

Example of CLOSED mode transmission intervals



Example of OPEN mode transmission intervals



As shown in the above figure, the 10 minute intervals are repeated until the message is acknowledged, the battery runs out, or the MOB device is turned off.

#### 3.6.1 How to acknowledge a DISTRESS RELAY or DISTRESS ALERT message from the MOB device

MOB device distress messages should be acknowledged within five minutes. Where the message is not acknowledged within five minutes, the MOB device may enter sleep mode. In sleep mode, the MOB device cannot receive the ACK signal and the FM-8900S shows an warning.

**Note:** The FM-8900S sends the ACK to not only the latest MOB device but can also send ACK to a maximum of 20 MOB devices.

#### DISTRESS RELAY

The example figure below shows the message window on the FM-8900S when the DISTRESS RELAY message is received from a MOB device.

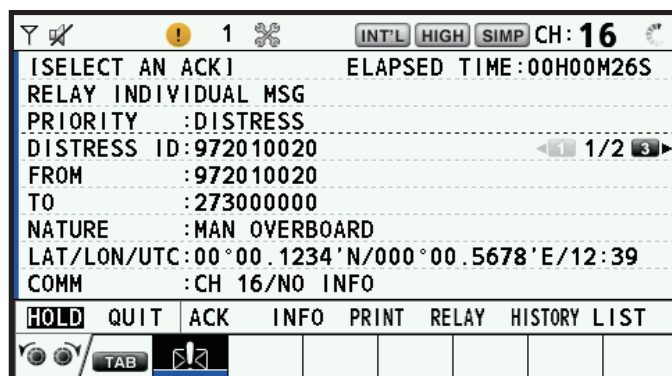

The example figure below shows the message window on the FM-8900S when the MOB procedure is activated.

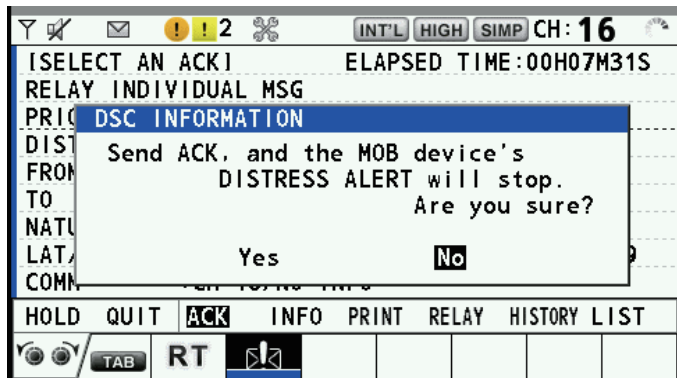

1. Press the [CANCEL] key to stop the alert and the flashing LED.  
**Note:** In a situation where more than one MOB distress message has been received, the alert terminates automatically and the pop-up message disappears automatically.
2. The pop-up message disappears.
3. If your ship is able to assist with rescue, set the procedure as [ACTIVE], and then select [ACK].
4. The popup message disappears and the ACK message is sent.
5. If you require assistance, set the procedure as [RELAY].

**DISTRESS ALERT**

The example figure below shows the message window on the FM-8900S when the DISTRESS ALERT message is received from a MOB device.



Referring to section 3.2, acknowledge the message.

### 3. DSC DISTRESS OPERATIONS

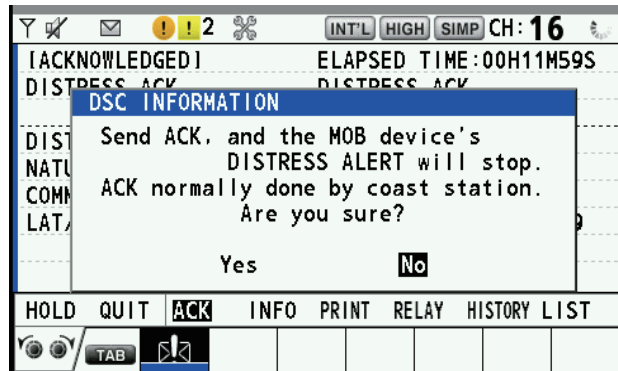

This popup appears when the ACK is transmitted

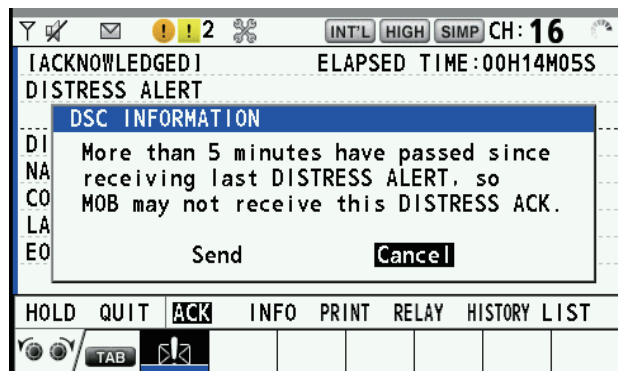

This popup appears when the ACK message is transmitted more than five minutes after the distress alert message was received.

**List option**

The [LIST] shows the latest 20 messages received from MOB devices. Message handling options can be selected from the list.

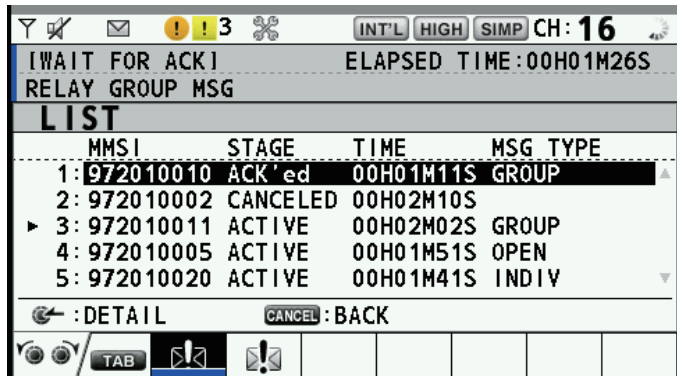

Messages with the same MMSI are overwritten when the message type changes. When a DSC message is received from a MOB device, the received message appears at the top of the screen.

When the message storage capacity is reached, the message shown below appears. Then, the oldest message is erased to make room for the latest.

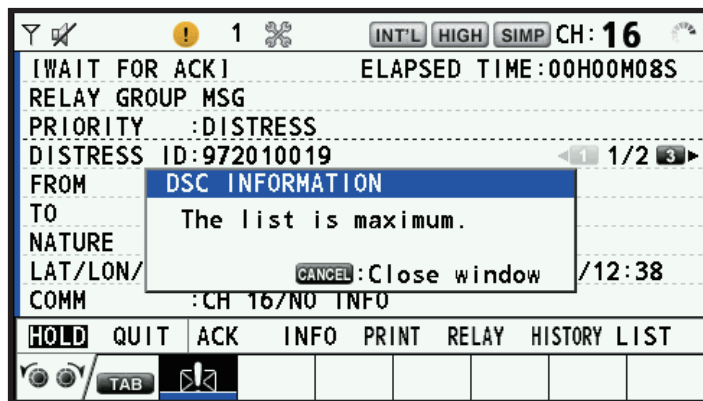

After the oldest message is erased, all messages are renumbered to reflect the change.

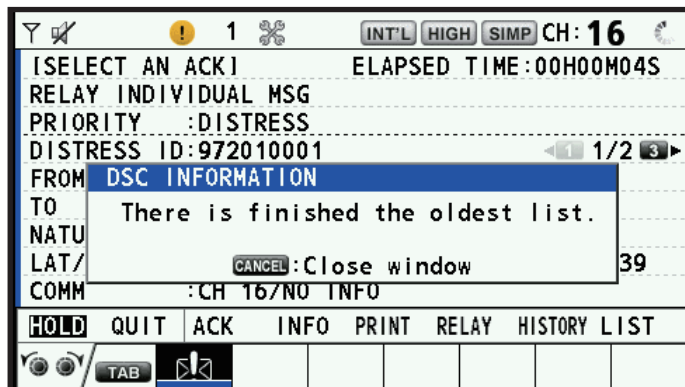

### 3. DSC DISTRESS OPERATIONS

This page is intentionally left blank.

# 4. DSC GENERAL MESSAGE CALLING, RECEIVING

## General procedure for non-distress DSC messages

The procedure for sending and receiving non-distress DSC messages is similar among message types. The following is an example of the sequence for an individual call.

1. Send the individual message.
2. Wait for the individual message acknowledgment.
3. Start the voice communication.

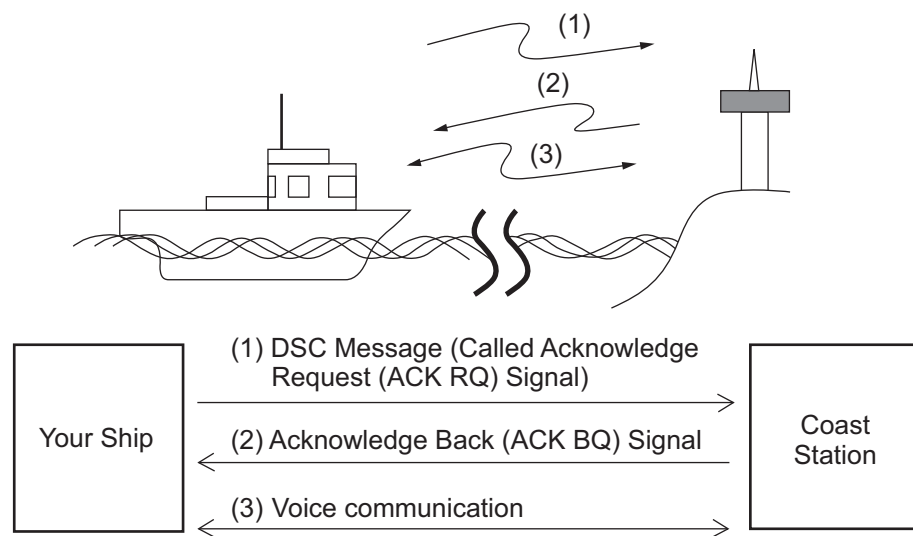

## 4.1 Individual Call

The individual call is for calling a specific station. After sending an individual call, called ACK RQ transmission, wait to receive the acknowledge back (ACK BQ) signal from the receiving station.

### 4.1.1 How to send an individual call

1. Press the **OTHER DSC MSG** key.

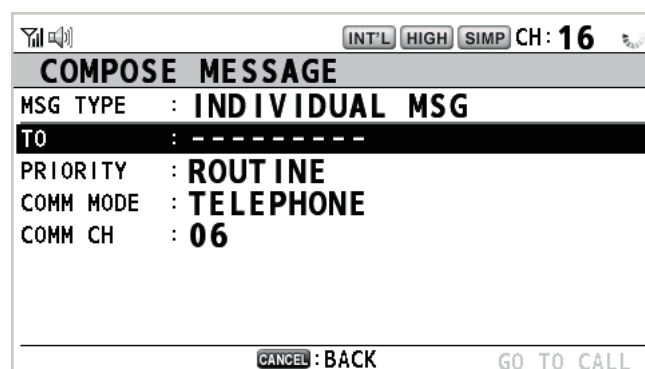

4. DSC GENERAL MESSAGE CALLING, RECEIVING

2. Rotate the **CHANNEL/ENTER** knob to select [MSG TYPE] then push the knob.

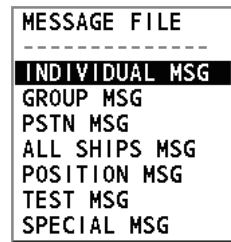

3. Rotate the **CHANNEL/ENTER** knob to select [INDIVIDUAL MSG] then push the knob.
4. With [TO] selected, push the **CHANNEL/ENTER** knob.

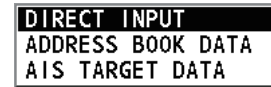

5. Rotate the **CHANNEL/ENTER** knob to select [DIRECT INPUT], [ADDRESS BOOK DATA] or [AIS TARGET DATA] then push the knob.  
 [DIRECT INPUT]: Enter the MMSI of the station where to send the call then push the **CHANNEL/ENTER** knob.  
 [ADDRESS BOOK DATA]: Select an MMSI from the [ADDRESS BOOK] (see section 5.13) then push the **CHANNEL/ENTER** knob.  
 [AIS TARGET DATA]: Select an MMSI from the [AIS TARGET LIST] then push the **CHANNEL/ENTER** knob.

AIS target list

If an AIS transponder is connected to the radiotelephone, you can select an MMSI from the [AIS TARGET LIST].

6. Rotate the **CHANNEL/ENTER** knob to select [PRIORITY] then push the knob.



7. Rotate the **CHANNEL/ENTER** knob to select [ROUTINE], [SAFETY] or [URGENCY] then push the knob.
8. With [COMM CH] selected, push the **CHANNEL/ENTER** knob.



9. Rotate the **CHANNEL/ENTER** knob to select [SELECT] or [MANUAL] then push the knob.

[SELECT]: The options window as shown in the right figure appears. Rotate the **CHANNEL/ENTER** knob to select the channel then push the knob.

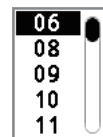

[MANUAL]: Enter the channel then push the **CHANNEL/ENTER** knob.

10. With [GO TO CALL] selected, push the **CHANNEL/ENTER** knob to send the individual call. The screen changes as shown below.

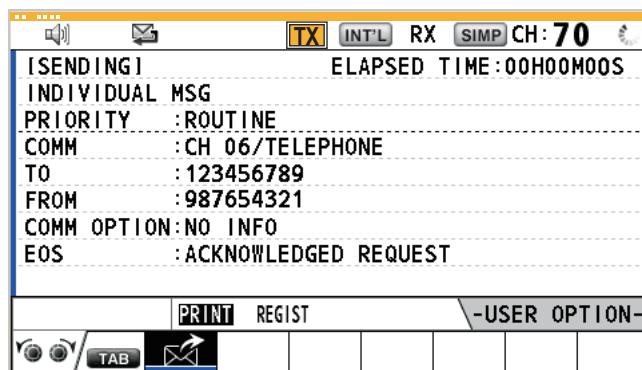



The timer starts counting up the time since the call was sent. After the call is sent, the equipment waits for acknowledgment of the call, showing the WAIT FOR ACK screen as below.

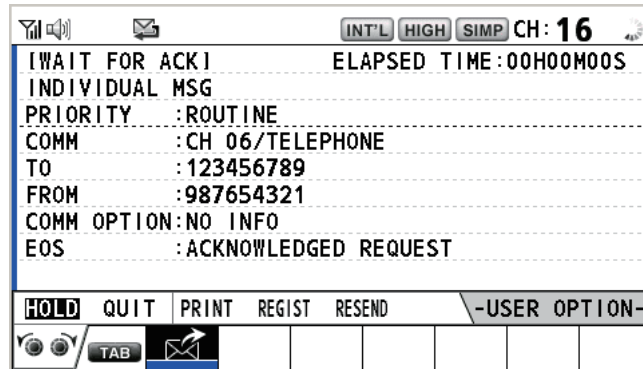

When the ACK is received, the audio alarm sounds and the pop-up message "ROUTINE (or SAFETY, URGENCY) INDIVIDUAL ACK received! [CANCEL]: Stop alarm" appears on the screen as below. The timer starts counting up the time since the ACK was received.

There are three types of ACK messages; [ABLE ACK], [UNABLE ACK] or [ABLE CHANGE CHANNEL ACK].

- Do one of the following depending on the message type shown at step 10.

#### **Able acknowledge call received**

- Press the **CANCEL** key to silence the audio alarm and erase the pop-up message.
- Communicate by radiotelephone.
- After you have completed communications, rotate the **CHANNEL/ENTER** knob to select [QUIT] in the user options area then push the knob.

#### **Able to change channel acknowledge call received**

This call means that the station you sent the individual call to accepts your call with the channel specified.

- Press the **CANCEL** key to silence the audio alarm and erase the pop-up message. The following message appears on the screen.

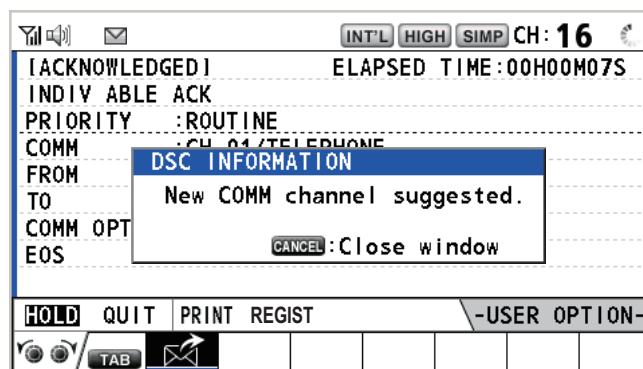

- Press the **CANCEL** key to erase the message. The working channel is changed to one that the station specified. You can now communicate by radiotelephone.
- After you have completed communications, rotate the **CHANNEL/ENTER** knob to select [QUIT] in the user options area then push the knob.

**Unable acknowledge call received**

- 1) Press the **CANCEL** key to silence the audio alarm and erase the pop-up message. The reason for [UNABLE ACK] is displayed on the screen.

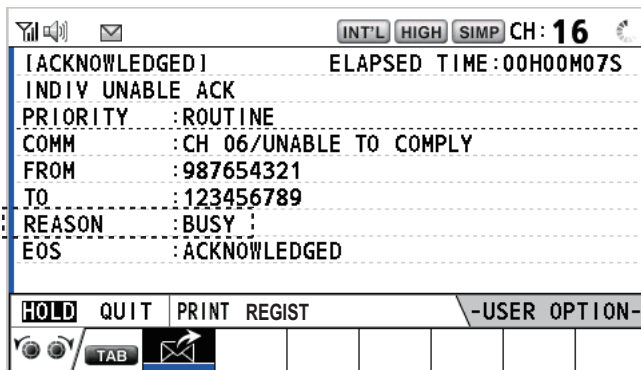

**Reason for unable to acknowledge**

- NO REASON : No reason given
- BUSY : Busy
- EQUIP ERROR : Equipment disabled
- CAN'T USE CH : Unable to use proposed channel
- CAN'T USE MODE : Unable to use proposed mode
- QUEUE INDICATION : Queue indication
- STATION BARRED : Station barred
- OPERATOR ABSENT : No operator available
- TEMP. UNAVAILABLE : Operator temporarily unavailable

- 2) Rotate the **CHANNEL/ENTER** knob to select [QUIT] in the user options area then push the knob.

**Note:** If the coast station sends the message "QUEUE INDICATION", wait until your turn comes.

If there is no response from the station, do one of the following procedures:

- **Resend call:** Rotate the **CHANNEL/ENTER** knob to select [RESEND] in the user options area then push the knob.
- **Cancel call:** Rotate the **CHANNEL/ENTER** knob to select [QUIT] in the user options area then push the knob. The message as shown in the right figure appears.

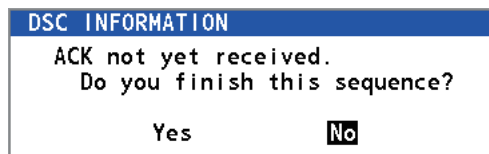

Rotate the **CHANNEL/ENTER** knob to select [Yes] then push the knob.

**4.1.2 How to receive an individual call**

Unable acknowledge is sent automatically or manually depending on the acknowledgment method setting (see section 5.16). Able acknowledge is sent only manually.

**Note:** All sessions must be quit or put on hold to enable automatic acknowledge.

**Send unable acknowledge automatically**

If the channel specified by the sending station is one that you cannot use, an unable acknowledge [CAN'T USE CH] is sent automatically. The [ACK SETTINGS] menu is set to [AUTO (UNABLE)]. It takes a few seconds to transmit the call.

**Send able/unable acknowledge manually**

When an individual call is received with the setting [MANUAL] on the [ACK SETTINGS] menu, the audio alarm sounds and the pop-up message "ROUTINE (SAFETY, URGENCY) INDIVIDUAL message received! [CANCEL]: Stop alarm" appears on the screen as below.

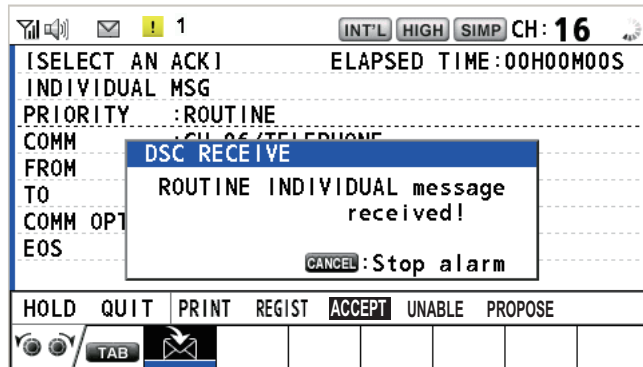

Press the **CANCEL** key to silence the audio alarm and erase the pop-up message. There are three types of ACK transmission; able acknowledge, able to change channel and unable acknowledge. Follow the appropriate procedure below.

- **How to send able acknowledge call**

1. With [ACCEPT] selected, push the **CHANNEL/ENTER** knob to send the able acknowledge call.
2. Communicate by radiotelephone.
3. After you have completed communications, rotate the **CHANNEL/ENTER** knob to select [QUIT] in the user options area then push the knob.

- **How to send unable acknowledge call**

1. Rotate the **CHANNEL/ENTER** knob to select [UNABLE] in the user options area then push the knob.

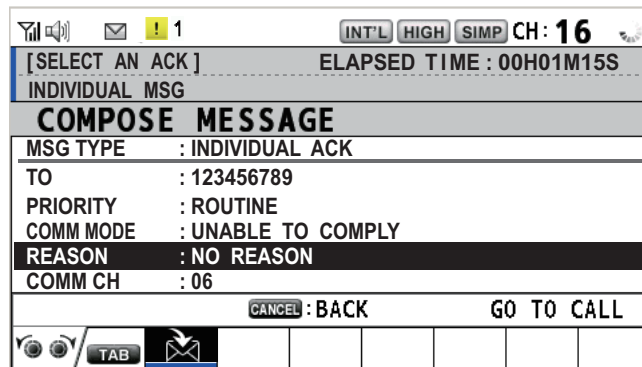

2. With [REASON] selected, push the **CHANNEL/ENTER** knob.

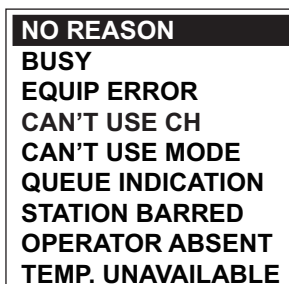

#### 4. DSC GENERAL MESSAGE CALLING, RECEIVING

3. Rotate the **CHANNEL/ENTER** knob to select the reason for unable then push the knob.
  4. With [GO TO CALL] selected, push the **CHANNEL/ENTER** knob to send unable acknowledge call.
- **How to send able acknowledge call and change channel**
    1. Rotate the **CHANNEL/ENTER** knob to select [PROPOSE] in the user options area then push the knob.

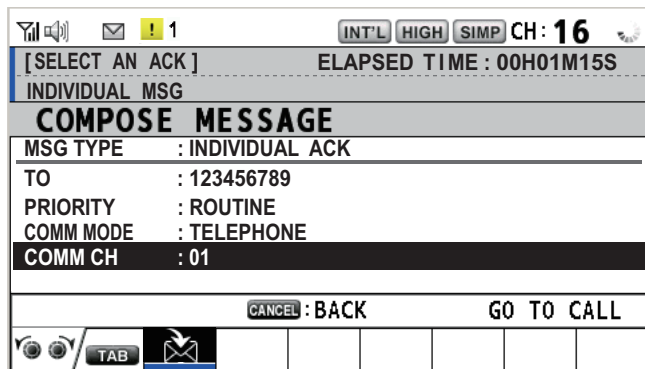

2. With [COMM CH] selected, push the **CHANNEL/ENTER** knob.
3. Rotate the **CHANNEL/ENTER** knob to select [SELECT] or [MANUAL] then push the knob.
  - [SELECT]: The options window appears. Rotate the **CHANNEL/ENTER** knob to select a channel then push the knob.
  - [MANUAL]: Enter a channel then push the **CHANNEL/ENTER** knob.
4. With [GO TO CALL] selected, push the **CHANNEL/ENTER** knob to send the able to change channel acknowledge call.
5. Communicate by radiotelephone.
6. After you have completed communications, rotate the **CHANNEL/ENTER** knob to select [QUIT] in the user options area then push the knob.

## 4.2 Group Call

A group call is for calling a specific group by specifying its group MMSI. When you set the group call in the address book, the group MMSI is automatically stored as your ship's group MMSI.

### 4.2.1 How to send a group call

1. Press the **OTHER DSC MSG** key.

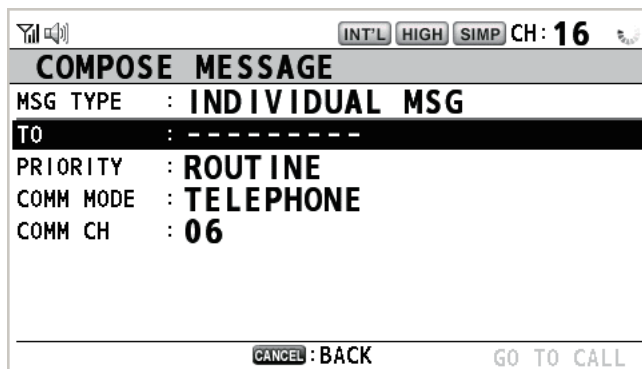

2. Rotate the **CHANNEL/ENTER** knob to select [MSG TYPE] then push the knob.
3. Rotate the **CHANNEL/ENTER** knob to select [GROUP MSG] then push the knob.

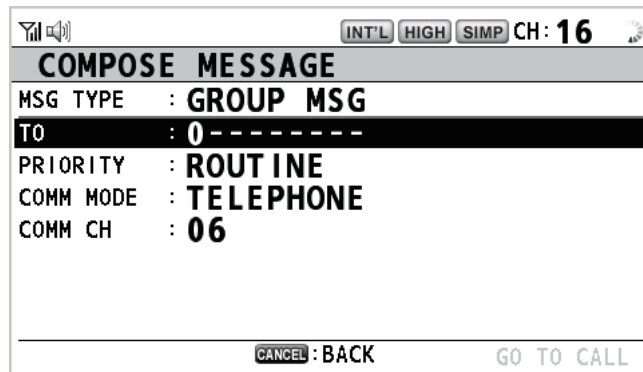

4. With [TO] selected, push the **CHANNEL/ENTER** knob.
5. Rotate the **CHANNEL/ENTER** knob to select [DIRECT INPUT] or [ADDRESS BOOK DATA] then push the knob.  
 [DIRECT INPUT]: Enter group MMSI (eight digits) with the numeric keys then push the **CHANNEL/ENTER** knob.  
 [ADDRESS BOOK DATA]: Select an MMSI from the [ADDRESS BOOK] (see section 5.13) then push the **CHANNEL/ENTER** knob.
6. With [COMM CH] selected, push the **CHANNEL/ENTER** knob.
7. Rotate the **CHANNEL/ENTER** knob to select [SELECT] or [MANUAL] then push the knob.  
 [SELECT]: The options window appears. Rotate the **CHANNEL/ENTER** knob to select the channel then push the knob.  
 [MANUAL]: Enter the channel then push the **CHANNEL/ENTER** knob.
8. With [GO TO CALL] selected, push the **CHANNEL/ENTER** knob to send the group call. The screen changes as below.

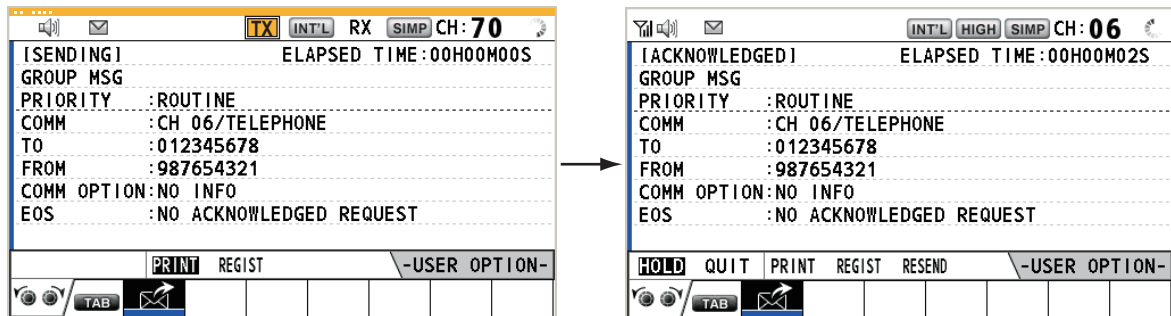

9. Communicate by radiotelephone.
10. After you have completed communications, rotate the **CHANNEL/ENTER** knob to select [QUIT] in the user options area then push the knob.

## 4.2.2 How to receive a group call

Group MMSI must be registered in order to receive a group call (see subsection 5.13.2).

When a group call is received, the audio alarm sounds. The icon (📧) appears in the tab area, and the pop-up message "GROUP message received! [CANCEL]: Stop alarm" appears.

#### 4. DSC GENERAL MESSAGE CALLING, RECEIVING

1. Press the **CANCEL** key to silence the audio alarm and erase the pop-up message. The channel is automatically tuned to the received channel.
2. Watch on the working channel. Communicate by radiotelephone.
3. After you have completed communications, rotate the **CHANNEL/ENTER** knob to select [QUIT] in the user options area then push the knob.

### 4.3 PSTN Call

The PSTN call allows the making and receiving of telephone calls over public switched telephone networks. To use the PSTN call feature, use a handset which has a HOOK ON/OFF function. The standard supply handset has this feature.

#### 4.3.1 How to send a PSTN call

1. Press the **OTHER DSC MSG** key.

The screenshot shows the 'COMPOSE MESSAGE' screen with the following settings: MSG TYPE: INDIVIDUAL MSG, TO: -----, PRIORITY: ROUTINE, COMM MODE: TELEPHONE, and COMM CH: 06. At the bottom, there are two options: CANCEL: BACK and GO TO CALL.

2. Rotate the **CHANNEL/ENTER** knob to select [MSG TYPE] then push the knob.
3. Rotate the **CHANNEL/ENTER** knob to select [PSTN MSG] then push the knob.

The screenshot shows the 'COMPOSE MESSAGE' screen with the following settings: MSG TYPE: PSTN MSG, TO: 00-----, COMM MODE: TELEPHONE, and TEL NO.: -----. At the bottom, there are two options: CANCEL: BACK and GO TO CALL.

4. With [TO] selected, push the **CHANNEL/ENTER** knob.
5. Rotate the **CHANNEL/ENTER** knob to select [DIRECT INPUT], [ADDRESS BOOK DATA] or [AIS TARGET DATA] then push the knob.  
[DIRECT INPUT]: Enter the MMSI of coast station (seven digits) with the numeric keys then push the **CHANNEL/ENTER** knob.  
[ADDRESS BOOK DATA]: Select an MMSI from the [ADDRESS BOOK] (see section 5.13) then push the **CHANNEL/ENTER** knob.  
[AIS TARGET DATA]: Select an MMSI from the [AIS TARGET LIST] then push the **CHANNEL/ENTER** knob.
6. With [TEL NO.] selected, push the **CHANNEL/ENTER** knob.
7. Enter telephone no. (up to 16 digits) with the numeric keys then push the **CHANNEL/ENTER** knob.

8. With [GO TO CALL] selected, push the **CHANNEL/ENTER** knob to send the PSTN call. After the call has been sent, the WAIT FOR ACK screen appears. The elapsed time since sending the call and the countdown for resending are displayed.

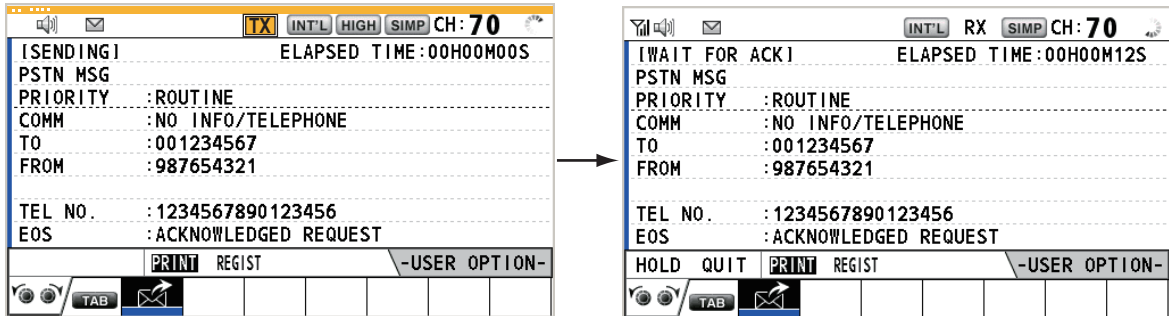

When you receive an acknowledge message, a pop-up message appears.

**Note:** The time period of countdown for resending is five seconds. After five seconds have passed, the call is resent. After five seconds have passed since re-sending the call, the pop-up message for time out or no response appears.

9. Do one of the following depending on ACK message.

#### **Able acknowledge message received**

If the PSTN call is accepted, the PSTN connection call is sent. When you receive the PSTN ACK message, the pop-up message "PSTN connected. Pick up HANDSET" appears and the audio alarm sounds. The communication channel changes.

**Note:** If you have already picked up the handset before the pop-up message appears, a pop-up message which suggests you to push the **CHANNEL/ENTER** knob appears. Push the **CHANNEL/ENTER** knob to accept.

1. Pick up the handset and communicate with the party you called. The elapsed time since starting communication is displayed.
2. To quit the communications, do one of the following.
  - On hook the handset. END OF CALL is sent automatically. The waiting ACK for END OF CALL screen appears. When you receive the ACK, rotate the **CHANNEL/ENTER** knob to select [QUIT] then push the knob.
 

**Note:** Be sure to on hook the handset to quit the communication so as not to incur further charges.
  - When the PSTN line is disconnected by the coast station, you receive the END OF CALL ACK message. Rotate the **CHANNEL/ENTER** knob to select [QUIT] then push the knob.

#### **Unable acknowledge message received**

When you receive an unable acknowledge message, the audio alarm sounds and a pop-up message appears. Rotate the **CHANNEL/ENTER** knob to select [QUIT] then push the knob.

### 4.3.2 How to receive a PSTN call

When a PSTN call is received, the  icon appears in the tab area. An able/unable acknowledge is sent automatically according to the setting of [PSTN] on the [ACK SETTINGS].

- [AUTO (ABLE)]: The automatic able acknowledge (which means you can communicate with party) is sent.
- [AUTO (UNABLE)]: The automatic unable acknowledge (which means you cannot communicate with party) is sent.

#### **Able acknowledgment**

The automatic able acknowledge is sent and the pop-up message "PSTN connected pick up HANDSET!" appears.

**Note:** If you have already picked up the handset before the pop-up message appears, a pop-up message which suggests you to push the **CHANNEL/ENTER** knob appears. Push the **CHANNEL/ENTER** knob to accept.

1. Pick up the handset. When you receive the PSTN ACK message, the screen for telephone calling appears. Communicate with the party. The elapsed time since starting communication is displayed.
2. To quit the communication, do one of the following.
  - On hook the handset. END OF CALL is sent automatically. The waiting ACK for END OF CALL screen appears. When you receive the ACK, rotate the **CHANNEL/ENTER** knob to select [QUIT] then push the knob.  
**Note:** Be sure to on hook the handset to quit the communication so as not to incur further charges.
  - When the PSTN line is disconnected by the coast station, you receive the END OF CALL ACK message. Rotate the **CHANNEL/ENTER** knob to select [QUIT] then push the knob.

After disconnection of the PSTN line, the END OF CALL ACK is sent.

#### **Unable acknowledgment**

The automatic unable acknowledge is sent. The audio alarm sounds and the LED flashes in green. Press the **CANCEL** key.

### 4.3.3 Caution for a PSTN call

After you send a PSTN call and receive an ACK (regardless of on hook or off hook condition), the following pop-up message appears.



On hook



Off hook

If you do not push the **CHANNEL/ENTER** knob or pick up the handset within 60 seconds, the PSTN call is disconnected because of timeout.



## 4.4 All Ships Call

When an urgent but not life-endangering situation arises on your ship, for example, engine trouble, send an all ships call to request assistance. After sending the call, you can communicate by radiotelephone. Do the following before beginning actual communications:

URGENCY priority: Say "PAN" three times followed by your call sign.

SAFETY priority: Say "SECURITE" three times followed by your call sign.

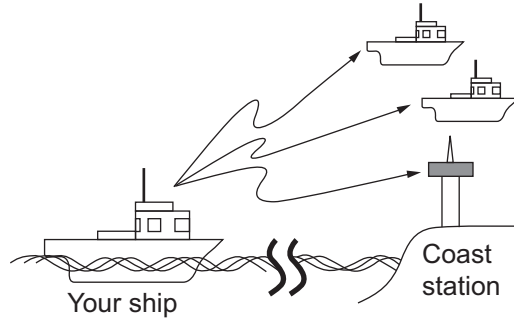

### 4.4.1 How to send an all ships call

1. Press the **OTHER DSC MSG** key.

COMPOSE MESSAGE	
MSG TYPE	: INDIVIDUAL MSG
TO	: - - - - -
PRIORITY	: ROUTINE
COMM MODE	: TELEPHONE
COMM CH	: 06
<span>CANCEL: BACK</span> <span style="float: right;">GO TO CALL</span>	

2. Rotate the **CHANNEL/ENTER** knob to select [MSG TYPE] then push the knob.
3. Rotate the **CHANNEL/ENTER** knob to select [ALL SHIPS MSG] then push the knob.

COMPOSE MESSAGE	
MSG TYPE	: ALL SHIPS MSG
PRIORITY	: SAFETY
COMM MODE	: TELEPHONE
COMM CH	: 16
<span>CANCEL: BACK</span> <span style="float: right;">GO TO CALL</span>	

4. With [PRIORITY] selected, push the **CHANNEL/ENTER** knob.

SAFETY
URGENCY

5. Rotate the **CHANNEL/ENTER** knob to select [SAFETY] or [URGENCY] then push the knob.
6. With [COMM CH] selected, push the **CHANNEL/ENTER** knob.

#### 4. DSC GENERAL MESSAGE CALLING, RECEIVING

7. Rotate the **CHANNEL/ENTER** knob to select [SELECT] or [MANUAL] then push the knob.  
[SELECT]: The options window appears. Rotate the **CHANNEL/ENTER** knob to select the channel then push the knob.  
[MANUAL]: Enter the channel then push the **CHANNEL/ENTER** knob.
8. With [GO TO CALL] selected, push the **CHANNEL/ENTER** knob to send the call. The screen changes as below.

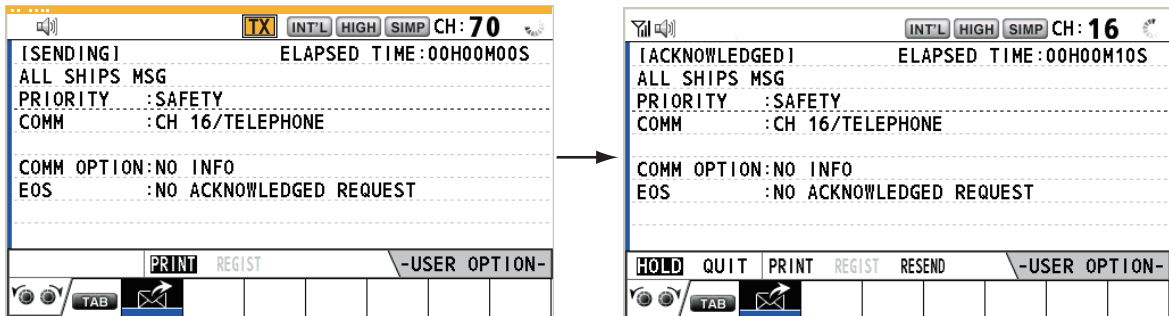

9. Communicate by radiotelephone.
10. After you have completed communications, rotate the **CHANNEL/ENTER** knob to select [QUIT] in the user options area then push the knob.

#### 4.4.2 How to receive an all ships call

When you receive an all ships call, the audio alarm sounds. The icon (📧) appears in the tab area, and the pop-up message "SAFETY (URGENCY) ALL message received! [CANCEL]: Stop alarm" appears.



1. Press the **CANCEL** key to silence the audio alarm and erase the pop-up message. The channel is automatically tuned to the received channel.

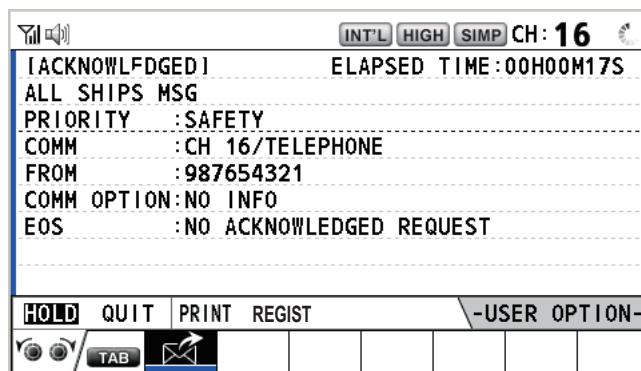

2. Watch on the working channel. Communicate by radiotelephone.
3. After you have completed communications, rotate the **CHANNEL/ENTER** knob to select [QUIT] in the user options area then push the knob.

## 4.5 Position Call

There are two types of position calls: your ship requests the position of another ship and other station requires your ship's position.

### Find position of other station

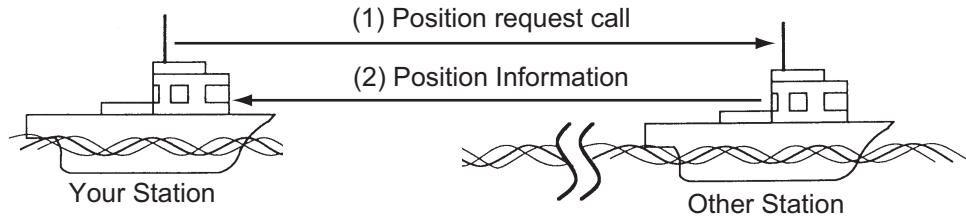

### Send your ship's position to other station

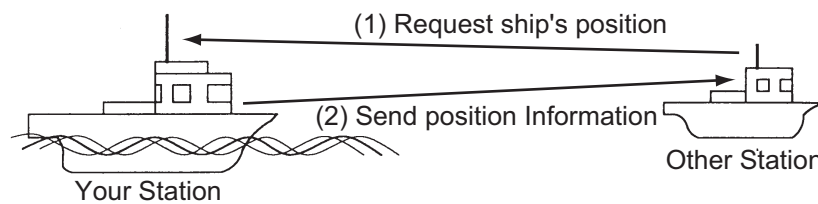

### 4.5.1 How to request other ship's position

1. Press the **OTHER DSC MSG** key.

INT'L HIGH SIMP CH: 16	
<b>COMPOSE MESSAGE</b>	
MSG TYPE	: INDIVIDUAL MSG
TO	: -----
PRIORITY	: ROUTINE
COMM MODE	: TELEPHONE
COMM CH	: 06
CANCEL: BACK GO TO CALL	

2. Rotate the **CHANNEL/ENTER** knob to select [MSG TYPE] then push the knob.
3. Rotate the **CHANNEL/ENTER** knob to select [POSITION MSG] then push the knob. [PRIORITY] is automatically selected to [SAFETY].

INT'L HIGH SIMP CH: 16	
<b>COMPOSE MESSAGE</b>	
MSG TYPE	: POSITION MSG
TO	: -----
PRIORITY	: SAFETY
CANCEL: BACK GO TO CALL	

4. With [TO] selected, push the **CHANNEL/ENTER** knob.

4. DSC GENERAL MESSAGE CALLING, RECEIVING

5. Rotate the **CHANNEL/ENTER** knob to select [DIRECT INPUT], [ADDRESS BOOK DATA] or [AIS TARGET DATA] then push the knob.
  - [DIRECT INPUT]: Enter the MMSI of station, which you want to know its position, with the numeric keys then push the **CHANNEL/ENTER** knob.
  - [ADDRESS BOOK DATA]: Select an MMSI from the [ADDRESS BOOK] (see section 5.13) then push the **CHANNEL/ENTER** knob.
  - [AIS TARGET DATA]: Select an MMSI from the [AIS TARGET LIST] then push the **CHANNEL/ENTER** knob.
6. With [GO TO CALL] selected, push the **CHANNEL/ENTER** knob to send the position call. After the call has been sent, the WAIT FOR ACK screen appears. The elapsed time since sending the call is displayed.

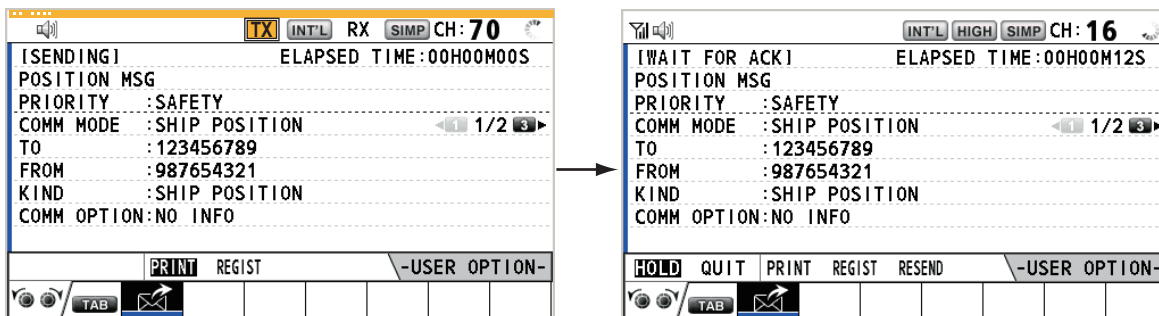

When you receive an acknowledge message, the audio alarm sounds and the pop-up message "POSITION ACK received! [CANCEL]: Stop alarm" appears.

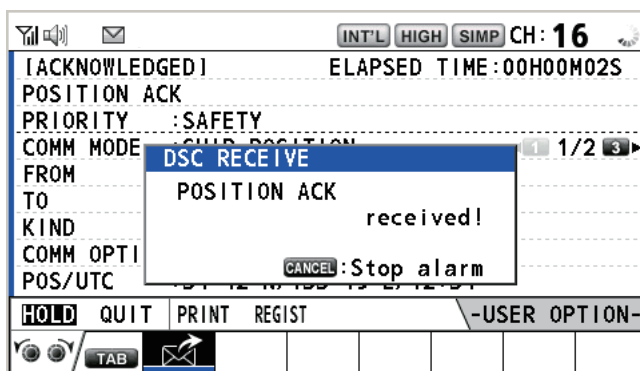

7. Press the **CANCEL** key to silence the audio alarm and erase the pop-up message. There are two types of ACK screens, one with position information and one with no position information.

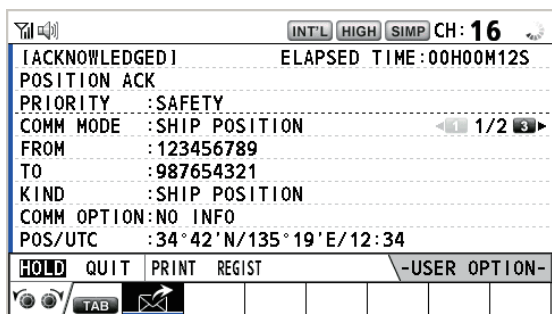

Position information included

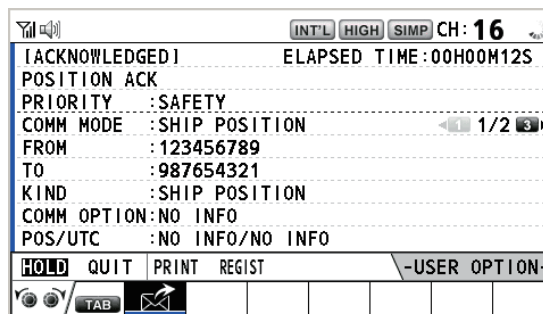

No position information

## 4.5.2 Other ship requests your position

You can turn automatic acknowledge of position request on with [POSITION MSG] on the [ACK SETTINGS] menu (see section 5.16).

### Automatic reply

When another ship requests your position and the setting of [POSITION MSG] on the [ACK SETTINGS] menu is [AUTO], the equipment automatically transmits a reply. There are two types of automatic replies, one with position information (the setting is [AUTO (ABLE)]) and the other with no position information (the setting is [AUTO (UNABLE)]).

### Manual reply

When a position request message is received and the setting of [POSITION MSG] on the [ACK SETTINGS] menu is [MANUAL], send the reply manually. To silence the audio alarm, press the **CANCEL** key.

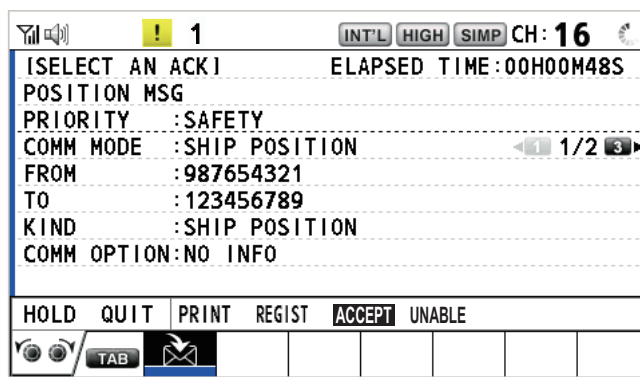

- **Send the ACK with position information:** With [ACCEPT] selected, push the **CHANNEL/ENTER** knob. The message with position information is sent.
- **Send the ACK with no position information:** Rotate the **CHANNEL/ENTER** knob to select [UNABLE] in the user options area then push the knob. The message with no position information is sent.

## 4.6 How to Receive a Polling Request

Polling means a coast station wants to confirm if it is within communicating range of your ship.

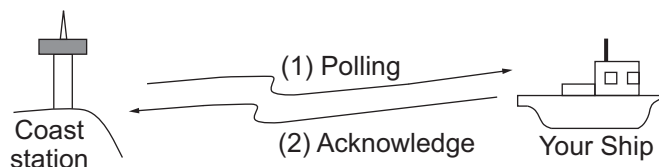

### 4.6.1 Automatic reply

When a polling request message is received with [AUTO] setting on [POLLING MSG] of the [ACK SETTINGS] menu, an acknowledge is sent automatically. See section 5.16.

## 4.6.2 Manual reply

When you receive a polling request message, the audio alarm sounds. The icon (✉) appears in the tab area, and the pop-up message shown below appears. The equipment is set up for manual acknowledge: [POLLING MSG] on the [ACK SETTINGS] menu is [MANUAL].



1. Press the **CANCEL** key to silence the audio alarm and erase the pop-up message.
2. Rotate the **CHANNEL/ENTER** knob to select [ACK] then push the knob to send the polling acknowledge message.
3. Rotate the **CHANNEL/ENTER** knob to select [QUIT] then push the knob.

## 4.7 Neutral Craft Call

The neutral craft call, which contains your MMSI, informs all ships that your ship is not a participant in an armed conflict. The neutral craft call must be enabled on the [SPECIAL MSG] menu. See section 5.17.

### 4.7.1 How to send a neutral craft call

1. Press the **OTHER DSC MSG** key.

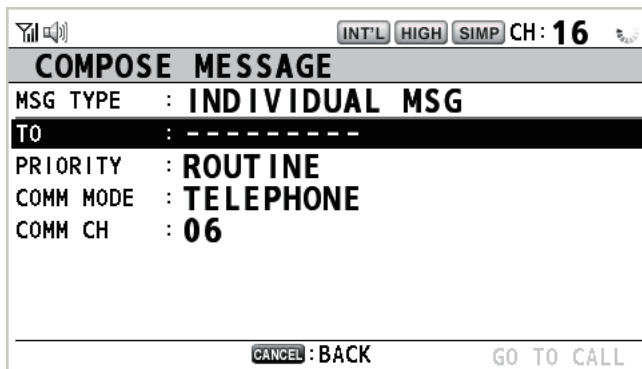

2. Rotate the **CHANNEL/ENTER** knob to select [MSG TYPE] then push the knob.
3. Rotate the **CHANNEL/ENTER** knob to select [SPECIAL MSG] then push the knob.

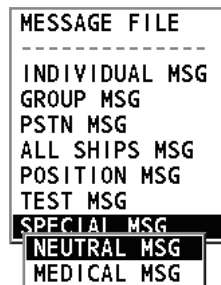

4. Rotate the **CHANNEL/ENTER** knob to select [NEUTRAL MSG] then push the knob. [PRIORITY] is automatically selected to [URGENCY].

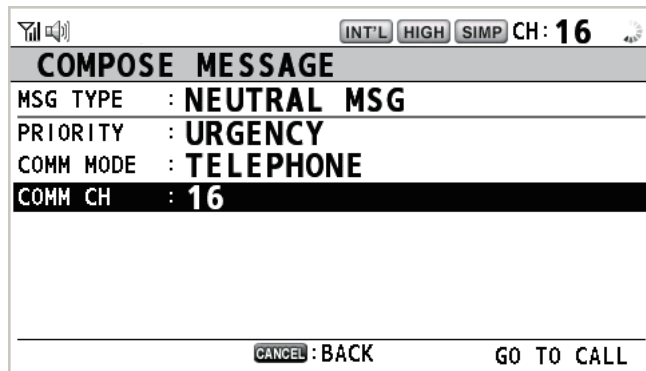

5. With [COMM CH] selected, push the **CHANNEL/ENTER** knob.
6. Rotate the **CHANNEL/ENTER** knob to select [SELECT] or [MANUAL] then push the knob.  
[SELECT]: The options window appears. Rotate the **CHANNEL/ENTER** knob to select the channel then push the knob.  
[MANUAL]: Enter the channel then push the **CHANNEL/ENTER** knob.
7. With [GO TO CALL] selected, push the **CHANNEL/ENTER** knob to send the neutral craft call.

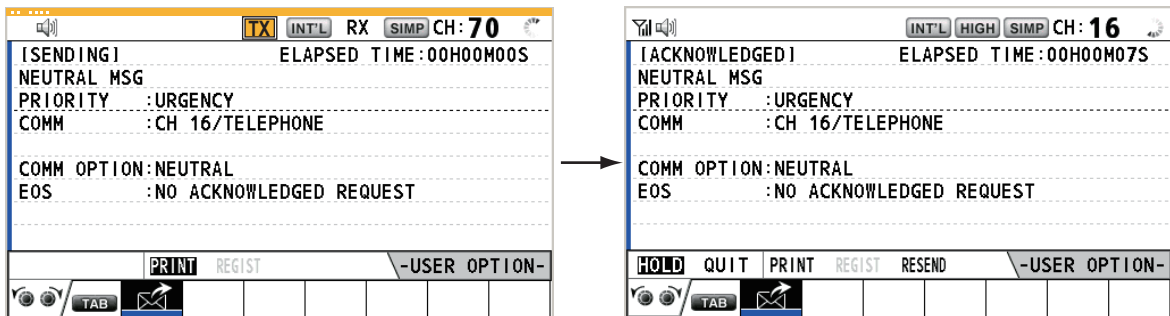

8. Inform all ships by radiotelephone that your ship is not a participant in armed conflict.
9. After you have completed communications, rotate the **CHANNEL/ENTER** knob to select [QUIT] in the user options area then push the knob.

## 4.7.2 How to receive a neutral craft call

When you receive a neutral craft call, the audio alarm sounds. The icon (📧) appears in the tab area, and the following pop-up message appears.



#### 4. DSC GENERAL MESSAGE CALLING, RECEIVING

1. Press the **CANCEL** key to silence the audio alarm and erase the pop-up message.

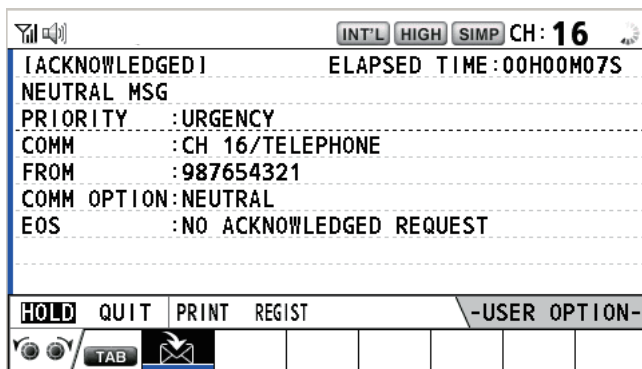

2. Watch on the working channel. Communicate by radiotelephone.
3. After you have completed communications, rotate the **CHANNEL/ENTER** knob to select [QUIT] in the user options area then push the knob.

## 4.8 Medical Transport Call

The medical transport call informs all ships, by urgency priority, that your ship carries medical supplies. The medical transport call must be enabled on the [SPECIAL MSG] menu. See section 5.17.

### 4.8.1 How to send a medical transport call

1. Press the **OTHER DSC MSG** key.

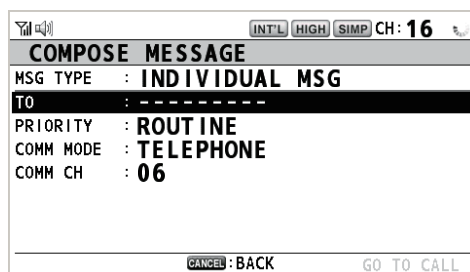

2. Rotate the **CHANNEL/ENTER** knob to select [MSG TYPE] then push the knob.
3. Rotate the **CHANNEL/ENTER** knob to select [SPECIAL MSG] then push the knob.
4. Rotate the **CHANNEL/ENTER** knob to select [MEDICAL MSG] then push the knob. [PRIORITY] is automatically selected to [URGENCY].

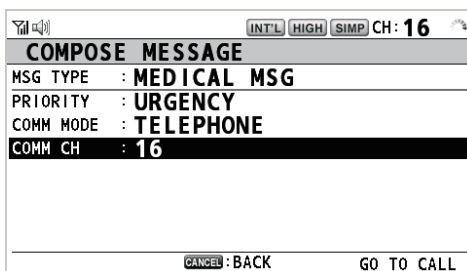

5. With [COMM CH] selected, push the **CHANNEL/ENTER** knob.



6. Rotate the **CHANNEL/ENTER** knob to select [SELECT] or [MANUAL] then push the knob.  
 [SELECT]: The options window appears. Rotate the **CHANNEL/ENTER** knob to select the channel then push the knob.  
 [MANUAL]: Enter the channel then push the **CHANNEL/ENTER** knob.
7. With [GO TO CALL] selected, push the **CHANNEL/ENTER** knob to send the medical transport call.

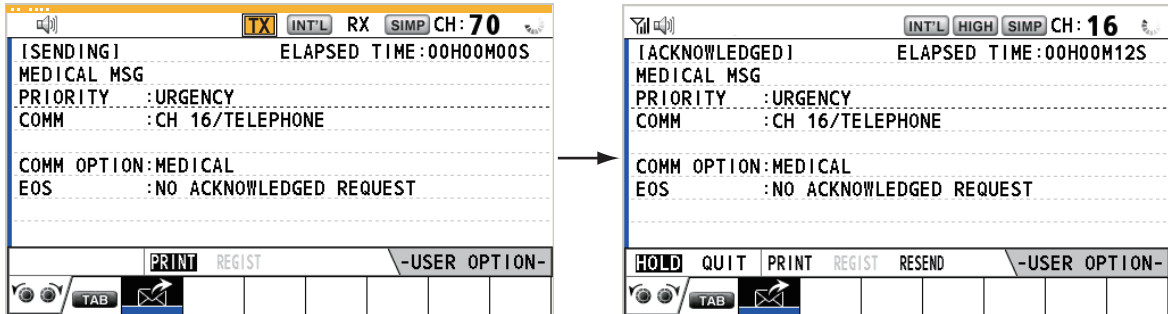

8. Inform all ships by radiotelephone that your ship is transporting medical supplies.
9. After you have completed communications, rotate the **CHANNEL/ENTER** knob to select [QUIT] in the user options area then push the knob.

## 4.8.2 How to receive a medical transport call

When you receive a medical transport call, the audio alarm sounds. The icon (✉) appears in the tab area, and the following pop-up message appears.



1. Press the **CANCEL** key to silence the audio alarm and erase the pop-up message.

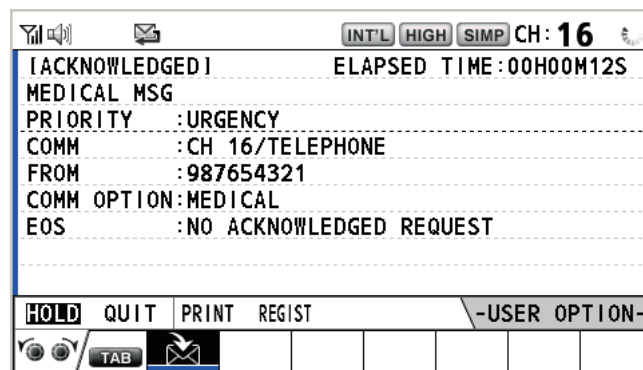

2. Watch on the working channel. Communicate by radiotelephone.
3. After you have completed communications, rotate the **CHANNEL/ENTER** knob to select [QUIT] in the user options area then push the knob.

## 4.9 Auto Channel Switching

By default, the system switches channels automatically based on the received DSC message. You can disable the auto switching feature, allowing you to focus on the task at hand.

**Note:** When [AUTO CH SWITCH] is set to [OFF], messages are received, but the channel is not changed until manually selected. For this reason, only set [AUTO CH SWITCH] to [OFF] when it safe to do so. For all other situations, set [AUTO CH SWITCH] to [ON].

To enable or disable automatic channel switching, follow the procedure below.

1. Press the **MENU** key to open the [MENU] screen.
2. Rotate the **CHANNEL/ENTER** knob to select [DSC], then push the knob.
3. Rotate the **CHANNEL/ENTER** knob to select [AUTO CH SWITCH], then push the knob.
4. Rotate the **CHANNEL/ENTER** knob to select [ON] or [OFF] as appropriate. Select [ON] to enable automatic channel switching. This is the default setting. Select [OFF] to disable automatic channel switching. When disabled, the icon shown below appears at the top-center of the screen to indicate that automatic channel switching is disabled.

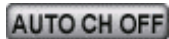

5. Close the menu.

# 5. MENU OPERATION

The menu can be accessed from both the RT and DSC screens.

**Note:** The menu can not be opened when awaiting acknowledgment of a distress alert.

## 5.1 How to Open/Close the MENU Screen

1. Press the **MENU** key to open the [MENU] screen.

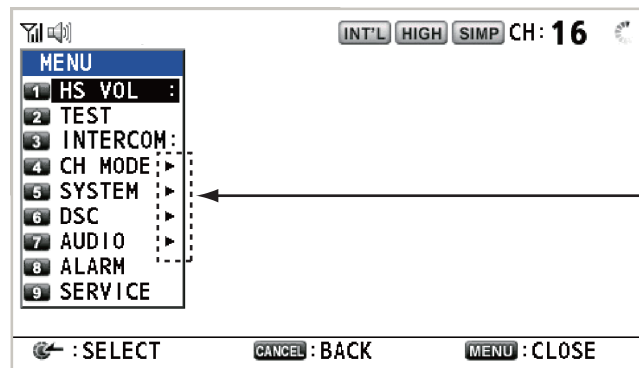

These marks indicate additional menus.

2. Rotate the **CHANNEL/ENTER** knob to select a desired menu item then push the knob. You can also select the desired menu item by pressing the **1** to **9** keys. The menu items that have a ► indicate additional menus.

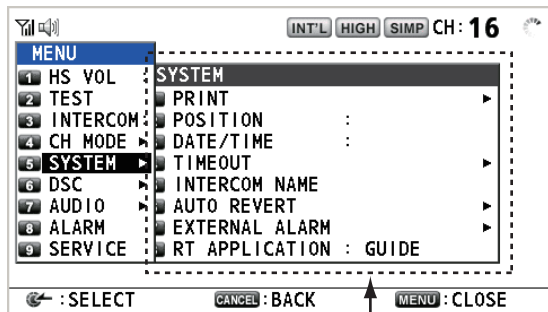

Menu items in next layer

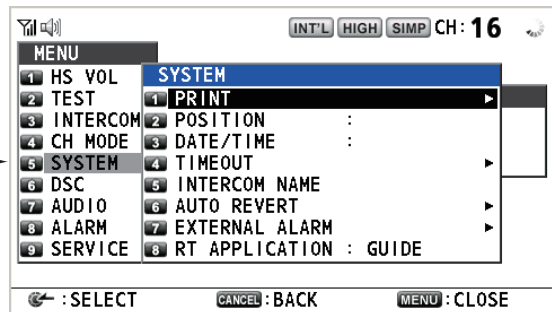

Second layer

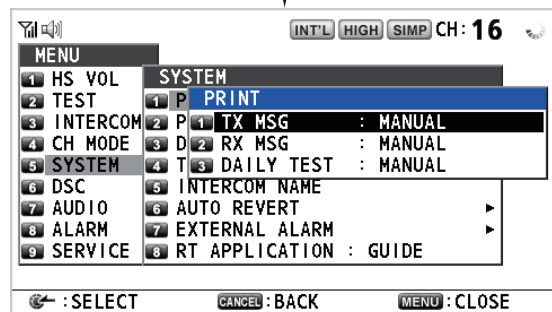

Third layer

3. To close the menu screen, press the **MENU** key.

**Note:** The **RT/REGION** key cancels menu operation and returns control to the RT screen.

## 5.2 Handset Volume Setting

You can adjust the volume of the loudspeaker for the handset.

1. Rotate the **CHANNEL/ENTER** knob to select [HS VOL] on the [MENU] screen then push the knob.
2. Rotate the **CHANNEL/ENTER** knob to set the volume level then push the knob.

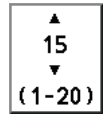

## 5.3 Channel Setting

### 5.3.1 Channel region

You can change the channel region (see section 1.5).

1. Rotate the **CHANNEL/ENTER** knob to select [CH MODE] on the [MENU] screen then push the knob.
2. With [REGION] selected, push the **CHANNEL/ENTER** knob.
3. Rotate the **CHANNEL/ENTER** knob to select the channel region, then push the knob.

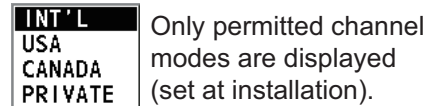

### 5.3.2 Memory

You can easily call up the channel which you registered in the [MEMORY CONFIG] menu (see section 5.4).

1. Rotate the **CHANNEL/ENTER** knob to select [CH MODE] on the [MENU] screen then push the knob.
2. Rotate the **CHANNEL/ENTER** knob to select [MEMORY] then push the knob.
3. Rotate the **CHANNEL/ENTER** knob to select [ON] or [OFF] then push the knob.  
When you select [ON], **M** appears on the screen. On the RT screen, you can select the memory channel by rotating the **CHANNEL/ENTER** knob. The following figure shows the example for CH 10.

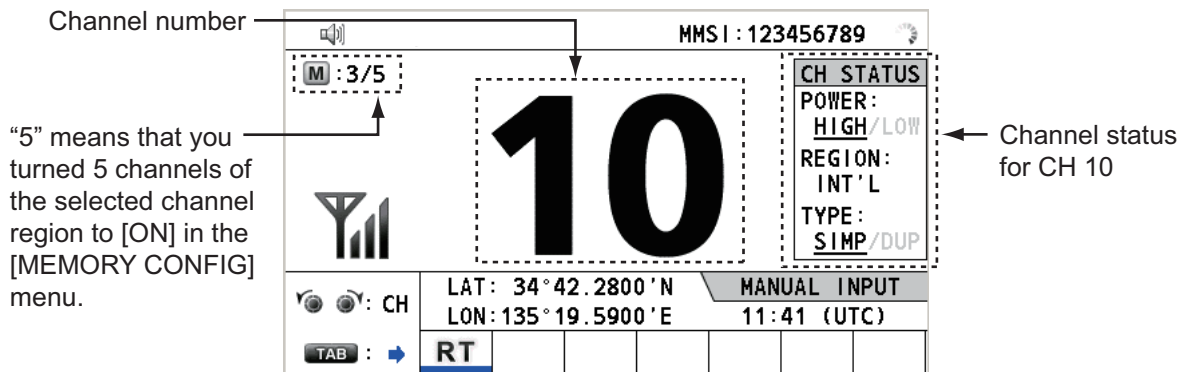

## 5.4 Memory Configuration

You can turn on or off memory channels on the [MEMORY CONFIG] screen. You can not turn off CH 16.

1. Rotate the **CHANNEL/ENTER** knob to select [CH MODE] on the [MENU] screen then push the knob.
2. Rotate the **CHANNEL/ENTER** knob to select [MEMORY CONFIG] then push the knob. The list for memory config appears.

INT'L		USA		WX:U		CANADA		WX:C		PRIVATE	
1/2	MEM	CH	MEM	CH	MEM	CH	MEM	CH	MEM	CH	MEM
01	! : --	08	--	15	--	22	--				
02	: --	09	--	16	ON	23	--				
03	: --	10	--	17	--	24	--				
04	: --	11	--	18	--	25	--				
05	: --	12	--	19	--	26	--				
06	: --	13	--	20	--	27	--				
07	: --	14	--	21	--	28	--				

← Channel region

3. Press the **4** or **6** key to switch the channel region.
4. When there are multiple pages, press the **1** key for the previous page and the **3** key for the next page.
5. Rotate the **CHANNEL/ENTER** knob to select the channel number then push the knob or the **8** key. Below is the example screen for the channel number 01 selected. The exclamation mark (!) and [ON] are displayed at each side of the selected channel number.

INT'L		USA		WX:U		CANADA		WX:C		PRIVATE	
1/2	MEM	CH	MEM	CH	MEM	CH	MEM	CH	MEM	CH	MEM
! 01	: ON	08	--	15	--	22	--				
02	: --	09	--	16	ON	23	--				
03	: --	10	--	17	--	24	--				
04	: --	11	--	18	--	25	--				
05	: --	12	--	19	--	26	--				
06	: --	13	--	20	--	27	--				
07	: --	14	--	21	--	28	--				

To erase a channel, select a channel to erase then push the **CHANNEL/ENTER** knob or the **8** key. The exclamation mark (!) and [ON] at each side of the selected channel number disappear.

6. Press the **MENU** key to save the setting.
7. Rotate the **CHANNEL/ENTER** knob to select [Yes] then push the knob.

Save Your Configuration.  
Are You Sure?  
Yes  No

To cancel the setting, press the **CANCEL** key instead of the **MENU** key at step 6. The message as shown in the right figure appears.

Exit Without Saving.  
Are You Sure?  
Yes  No

8. Rotate the **CHANNEL/ENTER** knob to select [Yes] then push the knob.

## 5.5 How to Print Messages

The [PRINT] menu enables/disables automatic printing of all transmitted and received calls and the results of the daily test.

1. Rotate the **CHANNEL/ENTER** knob to select [SYSTEM] on the [MENU] screen then push the knob.
2. Rotate the **CHANNEL/ENTER** knob to select [PRINT] then push the knob.
3. With [TX MSG] selected, push the **CHANNEL/ENTER** knob.
4. Rotate the **CHANNEL/ENTER** knob to select [AUTO] or [MANUAL] then push the knob.
5. Set [RX MSG] and [DAILY TEST] similarly.

PRINT		
1	TX MSG	: MANUAL
2	RX MSG	: MANUAL
3	DAILY TEST	: MANUAL

## 5.6 Position Setting

Do the following to set your position:

1. Rotate the **CHANNEL/ENTER** knob to select [SYSTEM] on the [MENU] screen then push the knob.
2. Rotate the **CHANNEL/ENTER** knob to select [POSITION SETUP] then push the knob.
3. Rotate the **CHANNEL/ENTER** knob to select [POSITION] then push the knob.
4. With [INPUT TYPE] selected, push the **CHANNEL/ENTER** knob.
5. Rotate the **CHANNEL/ENTER** knob to select [EPFS], [MANUAL] or [NO INFO] then push the knob.  
 [EPFS]: The position data from EPFS  
 [MANUAL]: Set the position data manually  
 [NO INFO]: No position data  
 For [MANUAL], go to the next step.
6. For manual input, use the numeric keys to enter current latitude/longitude position, and UTC. To change coordinate, select it and press the **1** key for North or East; the **2** key for South or West. Push the **CHANNEL/ENTER** knob after entering a line of data.

INPUT TYPE : EPFS	
LAT	◀ -
LON	◀ -
UTC	◀ -

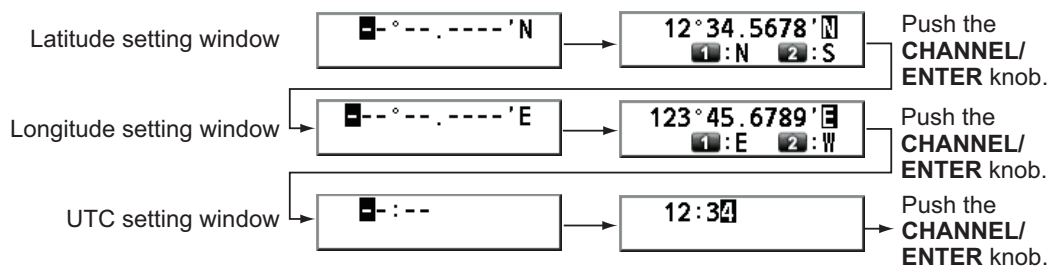

**Note:** When the setting of [INPUT TYPE] is [MANUAL], and position data is more than four hours old, the alert "(610)013 Position data is not updated! Position was older than 4H. Update it." is displayed. See "ALERT LIST AND CODES" on page AP-31 for details.

### 5.6.1 How to adjust the EPFS alarm message timing

The system outputs an EPFS alert when the position of Own Ship cannot be found. In some cases, the system is still obtaining information from connected sensors. In cases where system takes a short while to receive the position information, you can adjust the time it takes for the alert to appear.

[FIRST ALARM] sets the time to wait from when the power is turned on before releasing an EPFS alert.

**Note:** This setting only affects the first alert, all other EPFS alerts are not affected.

1. Rotate the **CHANNEL/ENTER** knob to select [SYSTEM] on the [MENU] screen then push the knob.
2. Rotate the **CHANNEL/ENTER** knob to select [POSITION SETUP] then push the knob.
3. Rotate the **CHANNEL/ENTER** knob to select [FIRST ALARM] then push the knob.

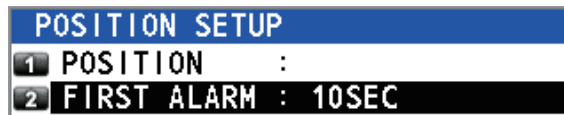

4. Rotate the **CHANNEL/ENTER** knob to set [FIRST ALARM] time, then push the knob. The setting range is 10 seconds to 600 seconds and the default setting is 60 seconds.

### 5.6.2 Position source priority

When more than one source of position data is available and POSITION SETUP is set to EPFS, the system automatically changes the position source (sensor) based on the priority outlined in the table below.

Talker priority	<ul style="list-style-type: none"> <li>• GN&gt;GP&gt;GA&gt;GL&gt;GB&gt;GQ&gt;GI&gt;OTHERS (for formatter GGA, GLL, RMC)</li> <li>• GN&gt;GP&gt;GL (for formatter GNS)</li> </ul>
Formatter priority	GNS>GGA>RMC>GLL

**Note:** When talker and formatter priorities are contradicting, formatter priority is selected. See the sentence definitions outlined in "DIGITAL INTERFACE".

## 5.7 Date and Time Setting

Set the date and time for the system.

1. Rotate the **CHANNEL/ENTER** knob to select [SYSTEM] on the [MENU] screen then push the knob.
2. Rotate the **CHANNEL/ENTER** knob to select [DATE/TIME] then push the knob.
  - The date or time cannot be adjusted when they are input from an EPFS navigator.
  - If date or time is not input from an EPFS navigator, enter the date and time with the numeric keys.

SOURCE : INTERNAL
DATE : --/--/----
TIME : --:--

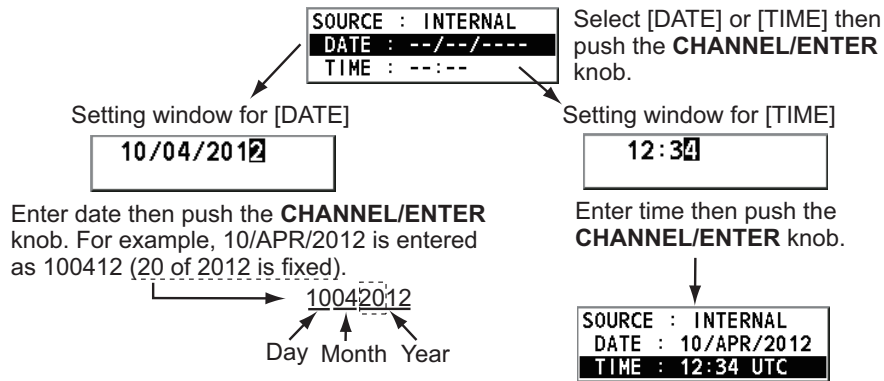

**Note:** When manually entering date and time, use UTC (Universal Time Coordinated). Do not use local time.

### Time Synchronization

The FM-8900S distinguishes between positioning time and system time. System time is used for alert management and the send and receive logs.

## 5.8 Timeout Setting

The menu screen and/or the inactive sessions (icons) can be closed automatically when there is no menu operation within the time specified. You can set the time interval for auto closing of the menu and inactive session.

1. Rotate the **CHANNEL/ENTER** knob to select [SYSTEM] on the [MENU] screen then push the knob.
2. Rotate the **CHANNEL/ENTER** knob to select [TIMEOUT] then push the knob.

TIMEOUT	
1 MENU END : 10MIN	
2 DSC GENERAL : 15MIN	
3 RX DISTRESS : NO TIMEOUT	
4 TELEPHONE : 30SEC	

3. Rotate the **CHANNEL/ENTER** knob to select the item desired then push the knob.
4. Rotate the **CHANNEL/ENTER** knob to select a time interval then push the knob. [NO TIMEOUT] leaves the menu screen and/or the inactive sessions open until you close them manually.

Item	Description	Option
[MENU END]	Close the menu screen automatically.	[10MIN], [NO TIMEOUT]



Item	Description	Option
[DSC GENER-AL]	Close the inactive sessions except the distress alert.	[15MIN], [NO TIMEOUT]
[RX DIS-TRESS]	Close the inactive sessions for the re-ceiving distress alert.	
[TELEPHONE]	Close the inactive sessions for RT.	[10SEC], [30SEC], [10MIN]

## 5.9 How to Name the Terminal for Intercom

You can change the name of the terminal for intercom.

1. Rotate the **CHANNEL/ENTER** knob to select [SYSTEM] on the [MENU] screen then push the knob.
2. Rotate the **CHANNEL/ENTER** knob to select [INTERCOM NAME] then push the knob.

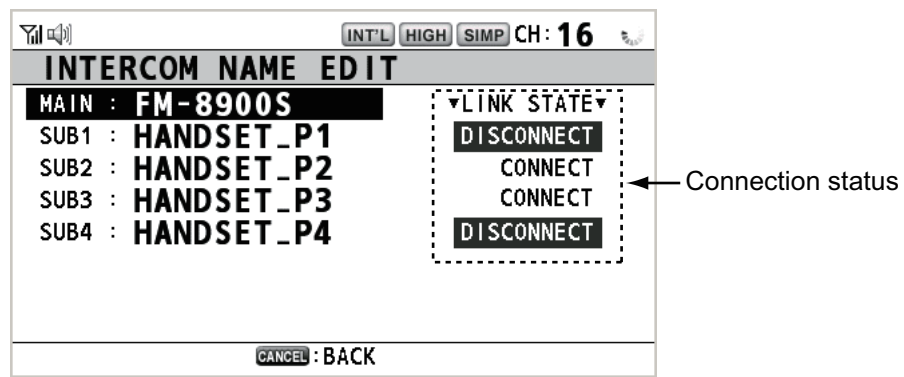

3. Rotate the **CHANNEL/ENTER** knob to select the terminal then push the knob.

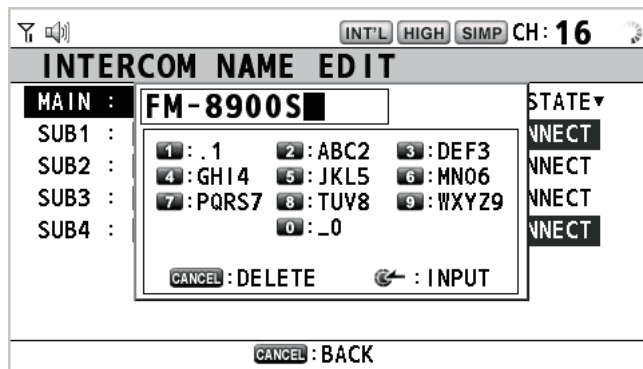

4. Rotate the **CHANNEL/ENTER** knob to select the character to edit then press the appropriate numeric key. To delete a character, rotate the **CHANNEL/ENTER** knob to select the character to delete then press the **CANCEL** key.

**F**M-8900S

1. Rotate the **CHANNEL/ENTER** knob to select "F".

**A**M-8900S

2. Press the appropriate numeric key (in this case, the 2 key) to change "F" to "A".

**Note:** Each time you press the 2 key, the character changes in the sequence of "A" → "B" → "C" → "2" → "A" → ...

5. Push the **CHANNEL/ENTER** knob.
6. Repeat steps 3 to 5 to name another terminal.

## 5.10 Automatic Switch to CH16

The channel can be automatically set to CH16 when the handset is on hooked.

1. Rotate the **CHANNEL/ENTER** knob to select [SYSTEM] on the [MENU] screen then push the knob.
2. Rotate the **CHANNEL/ENTER** knob to select [AUTO REVERT] then push the knob.

AUTO REVERT	
1	MAIN : RT+DSC
2	REMOTE : ON

3. Rotate the **CHANNEL/ENTER** knob to select [MAIN] (for the main unit) or [REMOTE] (for the remote handset) then push the knob.
4. For [MAIN], rotate the **CHANNEL/ENTER** knob to select [RT+DSC], [RT] or [OFF] then push the knob.

[RT+DSC]: Automatic switching to CH16 for all sessions

[RT]: Automatic switching to CH16 for the stand-by mode, the RT screen and the active RT session

[OFF]: No automatic switching

For [REMOTE], rotate the **CHANNEL/ENTER** knob to select [ON] or [OFF] then push the knob.

[ON]: Automatic switching to CH16 for the RT session

[OFF]: No automatic switching

**Note:** This function is not available during DW, scanning or PSTN.

## 5.11 External Alarm Setting

The [EXTERNAL ALARM] menu enables/disables output of the contact signal for urgency, safety and routine messages to an external alarm system.

1. Rotate the **CHANNEL/ENTER** knob to select [SYSTEM] on the [MENU] screen then push the knob.
2. Rotate the **CHANNEL/ENTER** knob to select [EXTERNAL ALARM] then push the knob.

EXTERNAL ALARM	
1	URGENCY : OFF
2	SAFETY : OFF
3	ROUTINE : OFF

3. Rotate the **CHANNEL/ENTER** knob to select [URGENCY], [SAFETY] or [ROUTINE] then push the knob.
4. Rotate the **CHANNEL/ENTER** knob to select [ON] or [OFF] then push the knob.
  - When receiving urgency, safety or routine messages, the contact signal for the category selected to ON is output to an external alarm system.
  - When receiving distress alert or distress messages, the contact signal is output to an external alarm system regardless of the external alarm setting.
  - When an alarm acknowledgment from an external alarm system is received by the transceiver unit or an alarm pop-up message closes (with pressing the **CANCEL** key, etc.), output of the contact signal to an external alarm system is stopped.

**Note:** An alarm pop-up message or audio alarm for the transceiver unit are not affected by this condition.

## 5.12 RT Application Setting

You can display the guide for operations, the handset state or the squelch values at the bottom left corner of the RT screen.

1. Rotate the **CHANNEL/ENTER** knob to select [SYSTEM] on the [MENU] screen then push the knob.
2. Rotate the **CHANNEL/ENTER** knob to select [RT APPLICATION] then push the knob.
3. Rotate the **CHANNEL/ENTER** knob to select [GUIDE], [HS STATE] or [SQ METER] then push the knob.

[GUIDE]: The guide for operations.

[HS STATE]: The remote handset state.

[SQ METER]: The squelch values for the transceiver unit and the remote handset.

[SP VOLUME]: Main speaker volume.

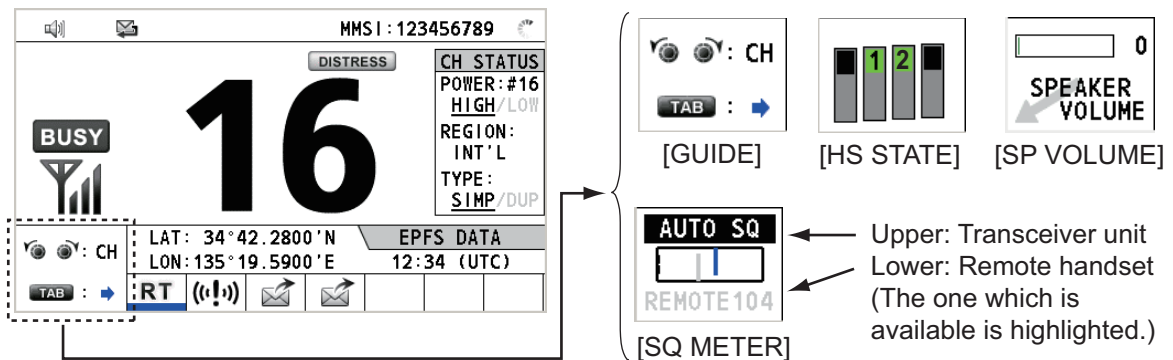

## 5.13 Address Book

You can register a maximum of 50 MMSIs and address names (max. 20 letters) in the memory.

### 5.13.1 List for address data

1. Rotate the **CHANNEL/ENTER** knob to select [DSC] on the [MENU] screen then push the knob.
2. Rotate the **CHANNEL/ENTER** knob to select [ADDRESS BOOK] then push the knob.

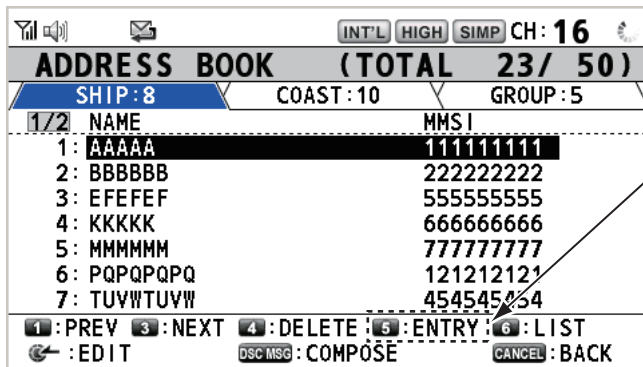

When 50 addresses have been registered, this is grayed out.

Key/knob	Function
<b>CHANNEL/ENTER</b>	<ul style="list-style-type: none"> <li>• Move the cursor by rotating the <b>CHANNEL/ENTER</b> knob.</li> <li>• Open the [ADDRESS DATA EDIT] screen by pushing the <b>CHANNEL/ENTER</b> knob (see subsection 5.13.3).</li> </ul>
<b>CANCEL</b>	Return to the [MENU] screen.
<b>OTHER DSC MSG</b>	Open the [COMPOSE MESSAGE] screen to create a DSC message with registered address (see subsection 5.13.5).
<b>1</b>	Go to the previous page.
<b>3</b>	Go to the next page.
<b>4</b>	Delete address (see subsection 5.13.4).
<b>5</b>	Open the [ADDRESS DATA ENTRY] screen (see subsection 5.13.2).
<b>6</b>	Switch the address type. Each press changes the type continuously ([SHIP] → [COAST] → [GROUP] → [SHIP] → ...).

### 5.13.2 How to register addresses

1. Open the [ADDRESS BOOK] screen.
2. Press the **5** key to open the [ADDRESS DATA ENTRY] screen.

INT'L HIGH SIMP CH: 16

**ADDRESS DATA ENTRY**

NAME : -----

MMSI : -----

<REGISTER>

CANCEL : BACK

3. With [NAME] selected, push the **CHANNEL/ENTER** knob.
4. Enter the address name (max. 20 letters) with the numeric keys then push the **CHANNEL/ENTER** knob.
5. With [MMSI] selected, push the **CHANNEL/ENTER** knob.

1 : . 1    2 : ABC2    3 : DEF3

4 : GH14    5 : JKL5    6 : MN06

7 : PQRS7    8 : TUV8    9 : WXYZ9

0 : \_0

CANCEL : DELETE    INPUT

-----

CANCEL : DELETE    INPUT

6. Enter the MMSI with the numeric keys then push the **CHANNEL/ENTER** knob.
7. With [REGISTER] selected, push the **CHANNEL/ENTER** knob.

### 5.13.3 How to edit addresses

1. Open the [ADDRESS BOOK] screen.
2. Rotate the **CHANNEL/ENTER** knob to select the address to edit then push the knob.

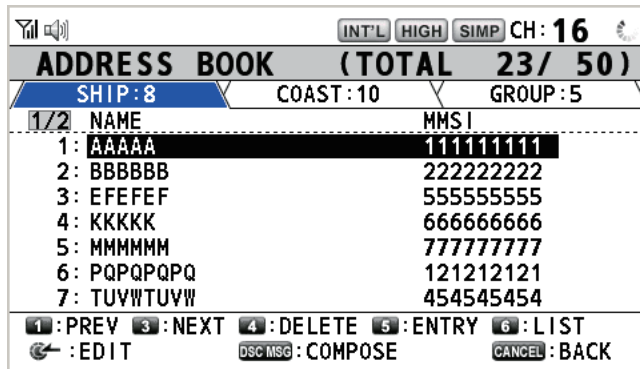

Push the **CHANNEL/ENTER** knob.

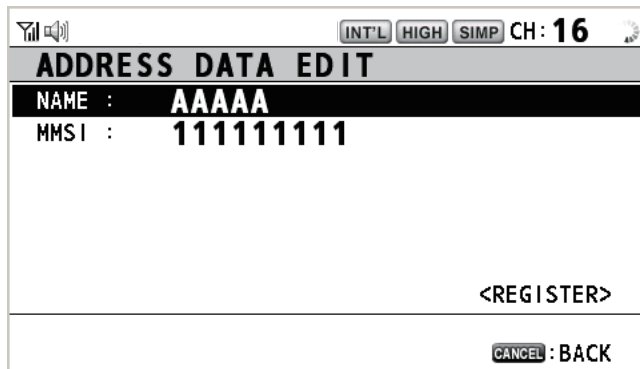

3. Rotate the **CHANNEL/ENTER** knob to select [NAME] or [MMSI] as appropriate then push the knob.
4. Enter the address name or MMSI with the numeric keys then push the **CHANNEL/ENTER** knob.
5. Rotate the **CHANNEL/ENTER** knob to select [REGISTER] then push the knob.

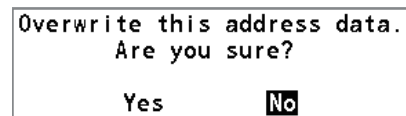

**Note:** If the MMSI is already registered to another address, the error alarm sounds and an alert pop-up message appears when selecting [REGISTER].

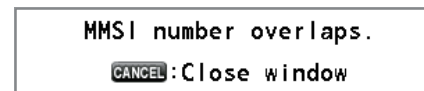

6. Rotate the **CHANNEL/ENTER** knob to select [Yes] then push the knob.

### 5.13.4 How to delete addresses

Open the [ADDRESS BOOK] screen then follow the applicable procedure below.

#### Individual address

1. Rotate the **CHANNEL/ENTER** knob to select the address to delete then press the **4** key.

<b>DELETE SELECTION</b>
DELETE LIST
DELETE ALL LISTS

2. Rotate the **CHANNEL/ENTER** knob to select [DELETE SELECTION] then push the knob.

Are You Sure?
Yes <b>No</b>

3. Rotate the **CHANNEL/ENTER** knob to select [Yes] then push the knob.

#### Address by type

1. Press the **6** key several times to select desired type.
2. Press the **4** key.
3. Rotate the **CHANNEL/ENTER** knob to select [DELETE LIST] then push the knob.
4. Rotate the **CHANNEL/ENTER** knob to select [Yes] then push the knob.

#### All addresses

1. Press the **4** key.
2. Rotate the **CHANNEL/ENTER** knob to select [DELETE ALL LISTS] then push the knob.
3. Rotate the **CHANNEL/ENTER** knob to select [Yes] then push the knob.

### 5.13.5 How to create a DSC message with registered address

1. Open the [ADDRESS BOOK] screen.
2. Rotate the **CHANNEL/ENTER** knob to select the address to use.
3. Press the **OTHER DSC MSG** key to open the [COMPOSE MESSAGE] screen.  
For the address type [SHIP] or [COAST], [MSG TYPE] is [INDIVIDUAL MSG]. For [GROUP], [MSG TYPE] is [GROUP MSG].

INT'L HIGH SIMP CH: 16

**ADDRESS BOOK (TOTAL 23/ 50)**

SHIP: 8 COAST: 10 GROUP: 5

1/2	NAME	MMSI
1	AAAAA	111111111
2	BBBBBB	222222222
3	EFEFEF	555555555
4	KKKKK	666666666
5	MMMMM	777777777
6	PQPQPQ	121212121
7	TUVWTVW	454545454

1: PREV 3: NEXT 4: DELETE 5: ENTRY 6: LIST  
 ← EDIT DSC MSG: COMPOSE CANCEL: BACK

Press the  
**OTHER DSC  
MSG** key.

→

INT'L HIGH SIMP CH: 16

**COMPOSE MESSAGE**

MSG TYPE : **INDIVIDUAL MSG**

TO : **11111111** AAAAAA

PRIORITY : **ROUTINE**

COMM MODE : **TELEPHONE**

COMM CH : **06**

CANCEL: BACK **GO TO CALL**

## 5.14 TX Message Preparation

For the individual, PSTN, group and test messages, you can create messages and store them in the memory for future use. You can edit, send or delete these messages. A maximum of 100 messages can be stored in the memory.

### 5.14.1 List for message files

1. Rotate the **CHANNEL/ENTER** knob to select [DSC] on the [MENU] screen then push the knob.
2. Rotate the **CHANNEL/ENTER** knob to select [MSG FILE] then push the knob.

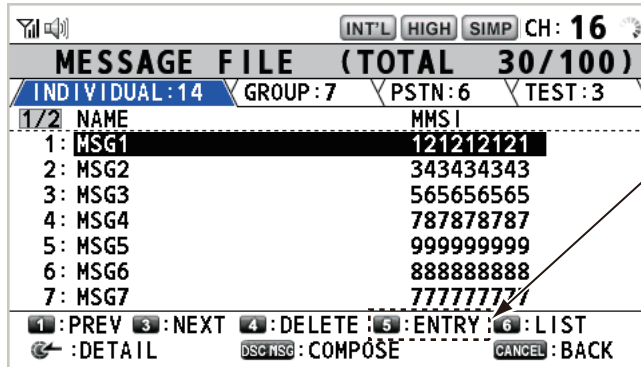

Key/knob	Function
<b>CHANNEL/ENTER</b>	<ul style="list-style-type: none"> <li>• Move the cursor by rotating the <b>CHANNEL/ENTER</b> knob.</li> <li>• Open the detailed information screen for the selected message file by pushing the <b>CHANNEL/ENTER</b> knob (see the following "Detailed information screen for message files").</li> </ul>
<b>CANCEL</b>	Return to the [MENU] screen.
<b>OTHER DSC MSG</b>	Open the [COMPOSE MESSAGE] screen to create a DSC message with registered message (see subsection 5.13.5).
<b>1</b>	Go to the previous page.
<b>3</b>	Go to the next page.
<b>4</b>	Delete messages (see subsection 5.14.8).
<b>5</b>	Open the [MESSAGE FILE ENTRY] screen.
<b>6</b>	Switch the message type. Each press changes the type continuously ([INDIVIDUAL] → [GROUP] → [PSTN] → [TEST] → [INDIVIDUAL] → ...).

#### Detailed information screen for message files

Rotate the **CHANNEL/ENTER** knob to select the message file desired on the [MESSAGE FILE] list then push the knob. The detailed information screen for the selected message file appears. The right figure shows the screen for an individual message.

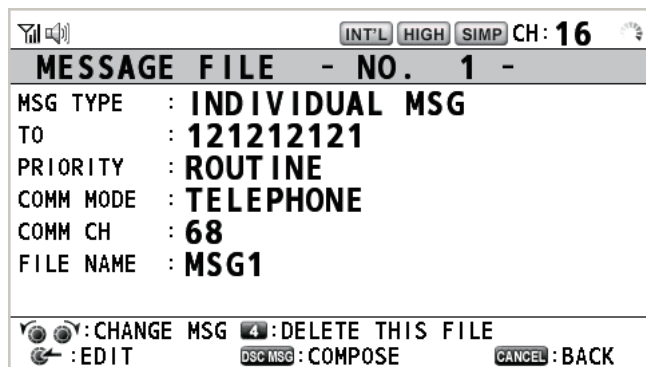



Several functions can be done from this screen.

- Rotating the **CHANNEL/ENTER** knob: Go to the detailed information screen for the previous or next message file.
- Pushing the **CHANNEL/ENTER** knob: Open the [MESSAGE FILE EDIT] screen (see subsection 5.14.6).
- **OTHER DSC MSG** key: Open the [COMPOSE MESSAGE] screen (see subsection 5.14.7).
- **4** key: Delete the selected message file. The confirmation message appears on the screen. Rotate the **CHANNEL/ENTER** knob to select [Yes] then push the knob.

### 5.14.2 Individual calls

1. Open the [MESSAGE FILE] list.
2. Press the **6** key several times to select the [INDIVIDUAL] type.
3. Press the **5** key to open the [MESSAGE FILE ENTRY] screen.

4. With [TO] selected, push the **CHANNEL/ENTER** knob.
5. Rotate the **CHANNEL/ENTER** knob to select [DIRECT INPUT], [ADDRESS BOOK DATA] or [AIS TARGET DATA] then push the knob.  
[DIRECT INPUT]: Enter the MMSI of the station where to send the call then push the **CHANNEL/ENTER** knob.

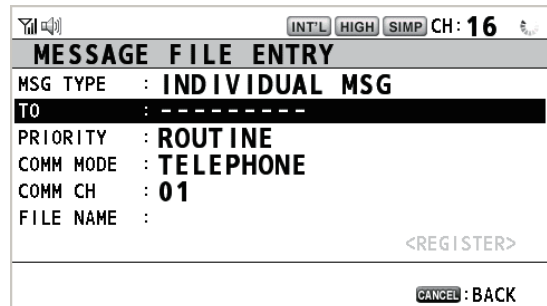

6. With [COMM CH] selected, push the **CHANNEL/ENTER** knob.
7. Rotate the **CHANNEL/ENTER** knob to select [SELECT] or [MANUAL] then push the knob.  
[SELECT]: The options window appears. Rotate the **CHANNEL/ENTER** knob to select the channel then push the knob.  
[MANUAL]: Enter the channel then push the **CHANNEL/ENTER** knob.
8. With [FILE NAME] selected, push the **CHANNEL/ENTER** knob.

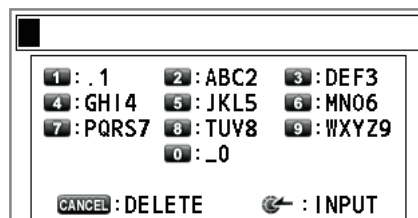



9. Enter the file name (max. 20 letters) with the numeric keys then push the **CHANNEL/ENTER** knob.
10. With [REGISTER] selected, push the **CHANNEL/ENTER** knob.

### 5.14.3 Group calls

To receive group calls, register the group MMSI in [ADDRESS BOOK].



1. Open the [MESSAGE FILE] list.
2. Press the **6** key several times to select the [GROUP] type.
3. Press the **5** key to open the [MESSAGE FILE ENTRY] screen.

  <span style="float: right;">INT'L HIGH SIMP CH: 16 </span>	
<b>MESSAGE FILE ENTRY</b>	
MSG TYPE	: <b>GROUP MSG</b>
<b>TO</b>	: <b>0-----</b>
PRIORITY	: <b>ROUTINE</b>
COMM MODE	: <b>TELEPHONE</b>
COMM CH	: <b>01</b>
FILE NAME	:
<b>&lt;REGISTER&gt;</b>	
<b>CANCEL : BACK</b>	

4. With [TO] selected, push the **CHANNEL/ENTER** knob.
5. Rotate the **CHANNEL/ENTER** knob to select [DIRECT INPUT] or [ADDRESS BOOK DATA] then push the knob.  
 [DIRECT INPUT]: Enter the group MMSI (eight digits) with the numeric keys then push the **CHANNEL/ENTER** knob.  
 [ADDRESS BOOK DATA]: Select an MMSI from the [ADDRESS BOOK] (see section 5.13) then push the **CHANNEL/ENTER** knob.
6. With [COMM CH] selected, push the **CHANNEL/ENTER** knob.
7. Rotate the **CHANNEL/ENTER** knob to select [SELECT] or [MANUAL] then push the knob.  
 [SELECT]: The options window appears. Rotate the **CHANNEL/ENTER** knob to select the channel then push the knob.  
 [MANUAL]: Enter the channel then push the **CHANNEL/ENTER** knob.
8. With [FILE NAME] selected, push the **CHANNEL/ENTER** knob.
9. Enter the file name (max. 20 letters) with the numeric keys then push the **CHANNEL/ENTER** knob.
10. With [REGISTER] selected, push the **CHANNEL/ENTER** knob.

### 5.14.4 PSTN calls



1. Open the [MESSAGE FILE] list.
2. Press the **6** key several times to select the [PSTN] type.
3. Press the **5** key to open the [MESSAGE FILE ENTRY] screen.

  <span style="float: right;">INT'L HIGH SIMP CH: 16 </span>	
<b>MESSAGE FILE ENTRY</b>	
MSG TYPE :	<b>PSTN MSG</b>
TO :	<b>00-----</b>
COMM MODE :	<b>TELEPHONE</b>
TEL NO. :	-----
FILE NAME :	
<REGISTER>	
CANCEL : BACK	

4. With [TO] selected, push the **CHANNEL/ENTER** knob.
5. Rotate the **CHANNEL/ENTER** knob to select [DIRECT INPUT], [ADDRESS BOOK DATA] or [AIS TARGET DATA] then push the knob.
  - [DIRECT INPUT]: Enter the MMSI of coast station (seven digits) with the numeric keys then push the **CHANNEL/ENTER** knob.
  - [ADDRESS BOOK DATA]: Select an MMSI from the [ADDRESS BOOK] (see section 5.13) then push the **CHANNEL/ENTER** knob.
  - [AIS TARGET DATA]: Select an MMSI from the [AIS TARGET LIST] then push the **CHANNEL/ENTER** knob.
6. With [TEL NO.] selected, push the **CHANNEL/ENTER** knob.
7. Enter the telephone no. (up to 16 digits) with the numeric keys then push the **CHANNEL/ENTER** knob.
8. With [FILE NAME] selected, push the **CHANNEL/ENTER** knob.
9. Enter the file name (max. 20 letters) with the numeric keys then push the **CHANNEL/ENTER** knob.
10. With [REGISTER] selected, push the **CHANNEL/ENTER** knob.

### 5.14.5 Test calls



1. Open the [MESSAGE FILE] list.
2. Press the **6** key several times to select the [TEST] type.
3. Press the **5** key to open the [MESSAGE FILE ENTRY] screen.

  <span style="float: right;">INT'L HIGH SIMP CH: 16 </span>	
<b>MESSAGE FILE ENTRY</b>	
MSG TYPE	: TEST MSG
TO	: -----
PRIORITY	: SAFETY
FILE NAME	:
<REGISTER>	
CANCEL : BACK	

4. With [TO] selected, push the **CHANNEL/ENTER** knob.
5. Rotate the **CHANNEL/ENTER** knob to select [DIRECT INPUT], [ADDRESS BOOK DATA] or [AIS TARGET DATA] then push the knob.  
 [DIRECT INPUT]: Enter the MMSI where to send the test message with the numeric keys then push the **CHANNEL/ENTER** knob.  
 [ADDRESS BOOK DATA]: Select an MMSI from the [ADDRESS BOOK] (see section 5.13) then push the **CHANNEL/ENTER** knob.  
 [AIS TARGET DATA]: Select an MMSI from the [AIS TARGET LIST] then push the **CHANNEL/ENTER** knob.
6. With [FILE NAME] selected, push the **CHANNEL/ENTER** knob.
7. Enter the file name (max. 20 letters) with the numeric keys then push the **CHANNEL/ENTER** knob.
8. With [REGISTER] selected, push the **CHANNEL/ENTER** knob.

### 5.14.6 How to edit prepared messages

1. Open the [MESSAGE FILE] list.
2. Rotate the **CHANNEL/ENTER** knob to select the message file to edit then push the knob.
3. Push the **CHANNEL/ENTER** knob to open the [MESSAGE FILE EDIT] screen.

  <span style="float: right;">INT'L HIGH SIMP CH: 16 </span>	
<b>MESSAGE FILE EDIT</b>	
MSG TYPE	: INDIVIDUAL MSG
TO	: 123456789
PRIORITY	: ROUTINE
COMM MODE	: TELEPHONE
COMM CH	: 16
FILE NAME	: MSG10
<REGISTER>	
CANCEL : BACK	

4. Rotate the **CHANNEL/ENTER** knob to select the item to edit then push the knob.
5. Change the setting accordingly.

6. Rotate the **CHANNEL/ENTER** knob to select [REGIS-TER] then push the knob.
7. Rotate the **CHANNEL/ENTER** knob to select [Yes] then push the knob.

Overwrite this file. Are you sure? Yes <b>No</b>
--

### 5.14.7 How to send prepared messages

#### How to send without modification

1. Open the [MESSAGE FILE] list.
2. Rotate the **CHANNEL/ENTER** knob to select the message file desired then press the **OTHER DSC MSG** key.
3. Rotate the **CHANNEL/ENTER** knob to select [GO TO CALL] then push the knob.

#### Edit before sending

Follow the procedure in subsection 5.14.6 and do the above procedure "How to send without modification".

### 5.14.8 How to delete prepared messages

Open the [MESSAGE FILE] list then follow the applicable procedure below.

#### Individual prepared message

1. Rotate the **CHANNEL/ENTER** knob to select the file to delete then press the **4** key.
2. Rotate the **CHANNEL/ENTER** knob to select [DELETE SELECTION] then push the knob.
3. Rotate the **CHANNEL/ENTER** knob to select [Yes] then push the knob.

<b>DELETE SELECTION</b> DELETE LIST DELETE ALL LISTS
--

Are You Sure? Yes <b>No</b>
--------------------------------

#### Prepared messages by type

1. Press the **6** key several times to select the desired type.
2. Press the **4** key.
3. Rotate the **CHANNEL/ENTER** knob to select [DELETE LIST] then push the knob.
4. Rotate the **CHANNEL/ENTER** knob to select [Yes] then push the knob.

#### All prepared messages

1. Press the **4** key.
2. Rotate the **CHANNEL/ENTER** knob to select [DELETE ALL LISTS] then push the knob.
3. Rotate the **CHANNEL/ENTER** knob to select [Yes] then push the knob.

## 5.15 Log File

Three logs are provided for storage of calls:

- [RX DISTRESS] (received distress log)
- [RX GENERAL] (received ordinary log)
- [TX] (transmitted log)

Each mode stores 50 calls. The latest call is saved as log no.1 and the log no. of all previous calls in that log increments by one. When the storage capacity is exceeded, the oldest call is deleted to make a room for the latest. The icon (☑) indicates unread calls. Received distress calls are automatically deleted after 48 hours.

### 5.15.1 How to open a log file

The procedure to open a log is common to all logs.

1. Rotate the **CHANNEL/ENTER** knob to select [DSC] on the [MENU] screen then push the knob.
2. Rotate the **CHANNEL/ENTER** knob to select [LOG] then push the knob.

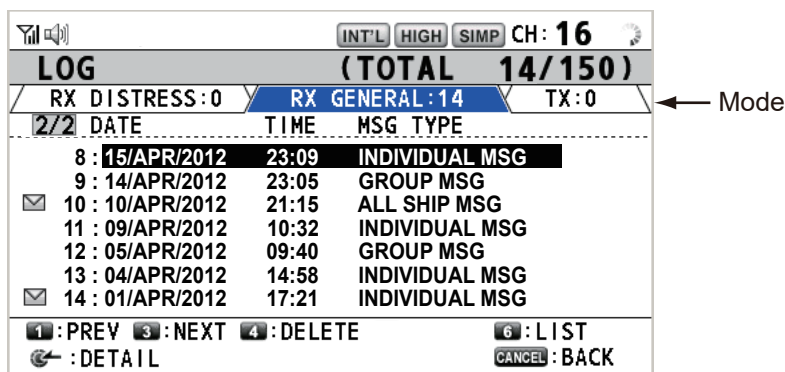

3. Press the **6** key to switch the log file mode in the sequence of [RX DISTRESS] → [RX GENERAL] → [TX] → [RX DISTRESS] → ...
4. When there are multiple pages, press the **1** key for the previous page and the **3** key for the next page. Rotate the **CHANNEL/ENTER** knob to select a desired log then push the knob. The contents of the selected log file are displayed. To return to the [MENU] screen, press the **CANCEL** key.

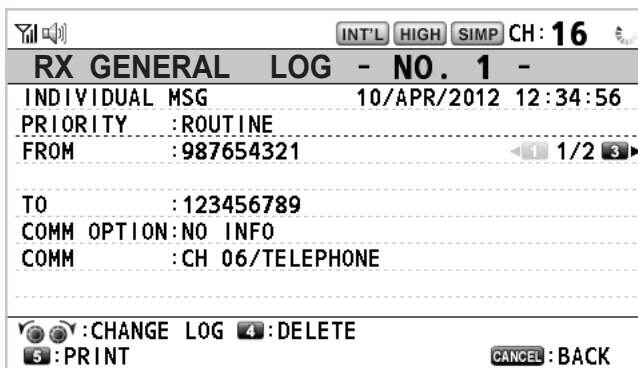

5. Press the **1** key for the previous page and the **3** key for the next page. Rotate the **CHANNEL/ENTER** knob to change the log file (clockwise rotation: to the next log file, counterclockwise rotation: to the previous log file).
6. To print the selected log, press the **5** key.
7. To return to the log list, press the **CANCEL** key.

## 5.15.2 How to delete log files

You can delete the log files except RX DISTRESS. Open the log file list then follow the applicable procedure below.

### Individual log file

1. Rotate the **CHANNEL/ENTER** knob to select the log file to delete then press the **4** key.
2. Rotate the **CHANNEL/ENTER** knob to select [DELETE SELECTION] then push the knob.
3. Rotate the **CHANNEL/ENTER** knob to select [Yes] then push the knob.

<b>DELETE SELECTION</b>
DELETE LIST
DELETE ALL LISTS

Are You Sure?
Yes <b>No</b>

You can delete a log file by pressing the **4** key on the screen shown at step 4 in subsection 5.15.1.

### Specify log files by mode

1. Press the **6** key several times to select [RX GENERAL] or [TX].
2. Press the **4** key.
3. Rotate the **CHANNEL/ENTER** knob to select [DELETE LIST] then push the knob.
4. Rotate the **CHANNEL/ENTER** knob to select [Yes] then push the knob.

### All log files

1. Press the **4** key.
2. Rotate the **CHANNEL/ENTER** knob to select [DELETE ALL LISTS] then push the knob.
3. Rotate the **CHANNEL/ENTER** knob to select [Yes] then push the knob.

Are You Sure? (Except RX DISTRESS)
Yes <b>No</b>

The log files are renumbered to reflect the deletion.

## 5.16 How to Set the AUTO ACK Details

The acknowledgment message can be sent automatically when you receive an individual message or a PSTN message. You can also enable or disable it for position, polling and test messages. For PSTN, position and polling messages, automatic acknowledgment is disabled when there is an active DSC session.

**Note 1:** For individual message, the automatic acknowledgment is automatically disabled, as required by law, when an RX call contains errors.

1. Rotate the **CHANNEL/ENTER** knob to select [DSC] on the [MENU] screen then push the knob.
2. Rotate the **CHANNEL/ENTER** knob to select [ACK SETTINGS] then push the knob.

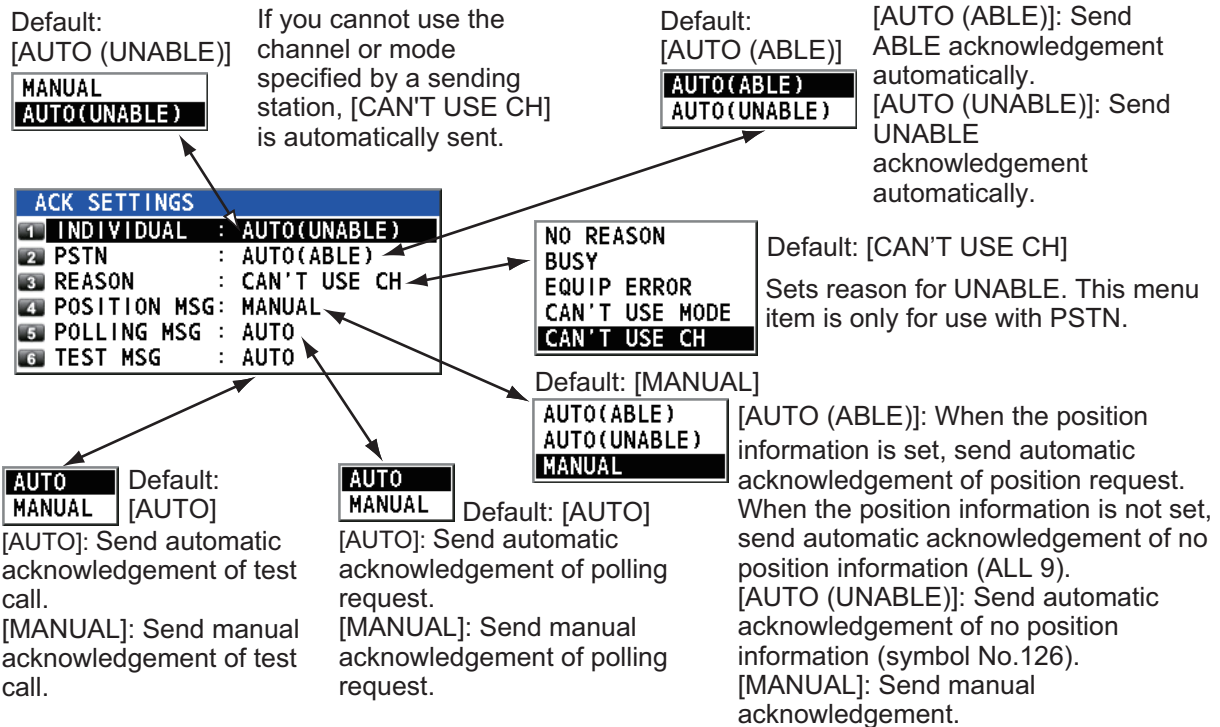

## 5.17 Special Messages

Permission to transmit NEUTRAL CRAFT and MEDICAL TRANSPORT is enabled or disabled as follows:

1. Rotate the **CHANNEL/ENTER** knob to select [DSC] on the [MENU] screen then push the knob.
2. Rotate the **CHANNEL/ENTER** knob to select [SPECIAL MSG] then push the knob.
3. Rotate the **CHANNEL/ENTER** knob to select [NEUTRAL] or [MEDICAL] then push the knob.
4. Rotate the **CHANNEL/ENTER** knob to select [ABLE] or [UNABLE] then push the knob.

SPECIAL MSG	
1	NEUTRAL : UNABLE
2	MEDICAL : UNABLE



## 5.18 Propose Channel Setting

When sending the automatic ACK to the PSTN call with no channel specified, your ship is required to propose a working channel. This proposal can be set as follows:

1. Rotate the **CHANNEL/ENTER** knob to select [DSC] on the [MENU] screen then push the knob.
2. Rotate the **CHANNEL/ENTER** knob to select [PROPOSE CH] then push the knob.

PROPOSE CH	
1	INT'L : 01
2	USA : 01
3	CANADA : 01
5	PRIVATE : 16

3. Rotate the **CHANNEL/ENTER** knob to select the channel region then push the knob.
4. Rotate the **CHANNEL/ENTER** knob to select the channel then push the knob.

## 5.19 Sound Setting

The [AUDIO] menu lets you set the volume for the following items:

- Key click on (setting: [1] - [3]) or off (setting: [0]) (Two beeps sound when a key in-operative in the ON mode (setting: [1] - [3]) is operated.)
- Speaker on or off with off hook for handset
- Speaker on or off for terminals except in-use one
- Volume of the receiving alarm for the safety and routine messages
- Adjust tone quality for speaker

Rotate the **CHANNEL/ENTER** knob to select [AUDIO] on the [MENU] screen then push the knob.

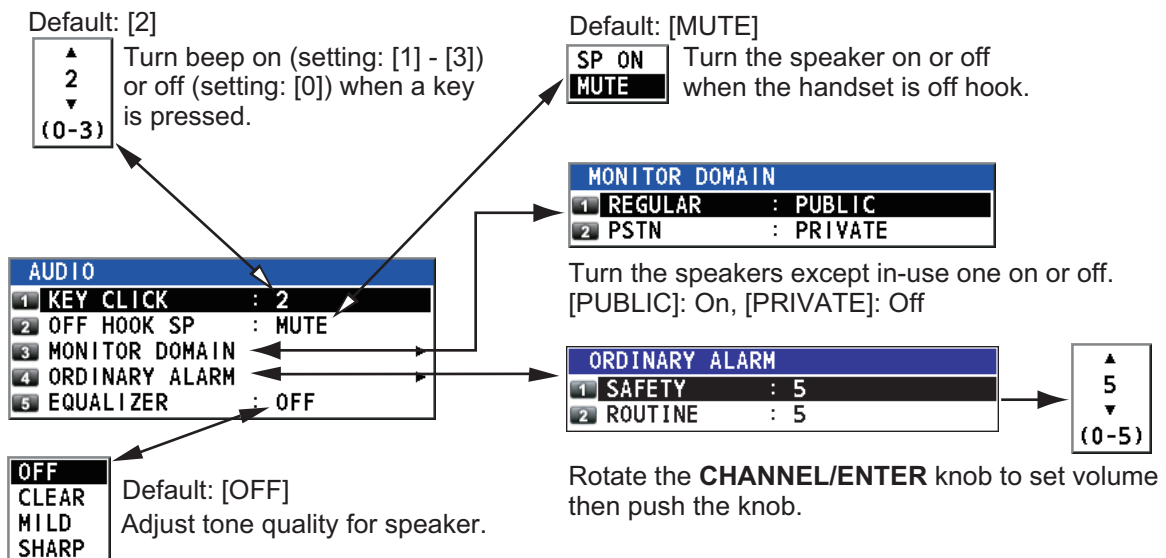

## 5.20 Alarm Lists

The [ALARM] menu shows all currently violated alarms. When an alert occurs, a pop-up message and a flashing alert icon appear on the screen. Press the **CANCEL** key to close the pop-up message and stop the flashing of the alert icon. When the cause of the alert is removed, the alert icon disappears.

Rotate the **CHANNEL/ENTER** knob to select [ALARM] on the [MENU] screen then push the knob. The following screen appears.

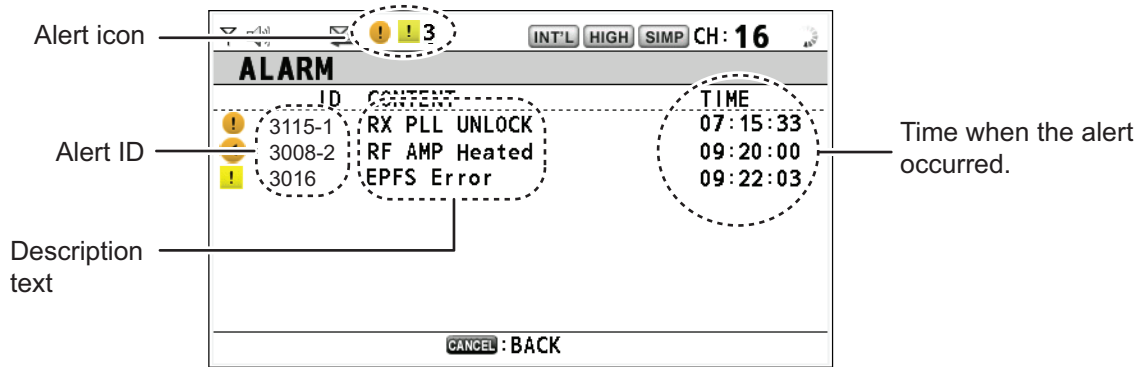

**Note:** The alert ID, alert icon and displayed message changes depending on whether a BAMS is connected.

If a BAMS is connected, the alert code is output in six digits (EG: "Position Lost" - 610014).

If no BAMS is connected, the alert code is output in three digits (EG: "Position Lost" - 014).

All alerts sent to the AMS (Alert Management System) are displayed in the order of occurrence. AMS includes Bridge Alert Management Systems (BAMS).

Depending on whether your AMS is connected or not, the manner in which alerts are removed from the list differs as follows.

- **No AMS connected:** The cause of the alert is removed or rectified.
- **AMS is connected:** The alert has been acknowledged (ACK'd) and the cause of the alert has been removed or rectified.

The table below shows a list of alerts, in BAMS ID format.

Alert ID	Description Text	Alert ID	Description Text
3013	No Position Update	610014	Position Lost
3008-1	TX PLL UNLOCK	3008-2	RF AMP Heated
3115-1	RX PLL UNLOCK	3115-2	DSC PLL UNLOCK
3016	EPFS Error	3122-x	DISTRESS: RX
3122-x	URGENCY: RX	3123-x	SAFETY: xxx
3123-x	ROUTINE: xxx		

"x": denotes instance number (between 1 and 7).

"xxx": denotes the alert message associated with the instance number.

See "ALERT LIST AND CODES" on page AP-31 for a full list of alerts, their codes and measures.

# 6. REMOTE HANDSET

## 6.1 Controls

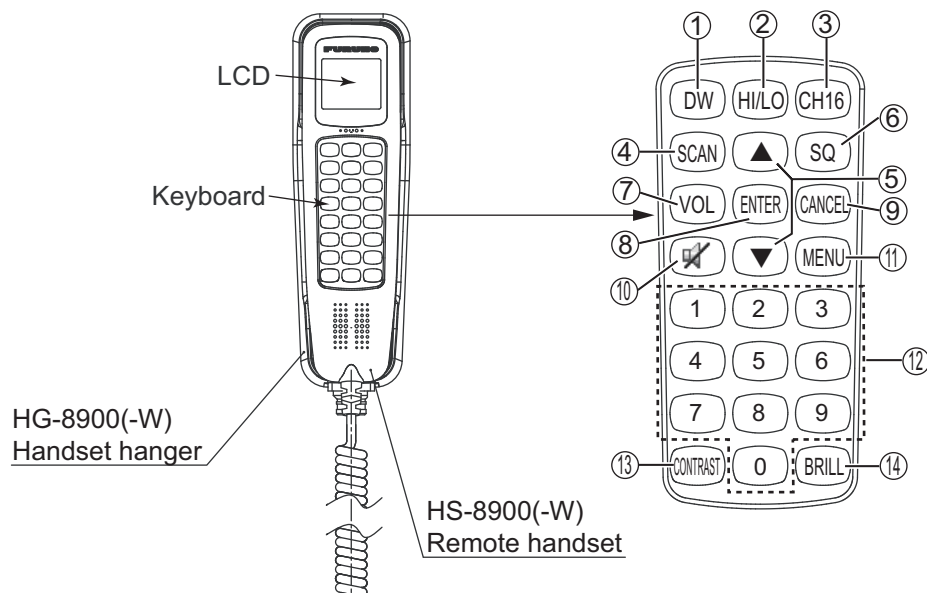

*Remote station RB-8900(-W) (option)*

### Description of controls for remote handset

No.	Control	Function
1	DW key	Turns the DW function on or off (see section 1.9).
2	HI/LO key	Changes the output power to high (25 W) or low (1 W).
3	CH16 key	Switches to the RT (radiotelephone) screen and sets CH16.
4	SCAN key	Turns the scan function on or off (see section 1.10).
5	▲, ▼ keys	<ul style="list-style-type: none"> <li>• Selects the menu items.</li> <li>• Selects the channel on the RT screen.</li> <li>• Adjusts the setting values.</li> </ul>
6	SQ key	Adjusts the squelch. Press the <b>SQ</b> key on the RT/OCCUPIED screen then press the ▲ or ▼ key within three seconds to adjust the squelch (setting range: AUTO, 0 to 10). To get auto squelch adjustment, press the ▼ key with the setting 0 (indication: SQA).
7	VOL key	Adjusts the volume. Press the <b>VOL</b> key on the RT/OCCUPIED screen then press the ▲ or ▼ key within three seconds to adjust the volume (setting range: 0 to 10).
8	ENTER key	<ul style="list-style-type: none"> <li>• Moves down one layer when you save the menu option in a layer other than the lowest one. In the undermost layer, opens the setting window.</li> <li>• Confirms a selection.</li> </ul>
9	CANCEL key	<ul style="list-style-type: none"> <li>• Silences the audio alarm.</li> <li>• Returns one layer in a multi-layer menu. In the top layer, closes the menu then displays the RT screen.</li> <li>• Cancels the setting in the setting window then goes back one layer in the menu.</li> <li>• Cancels the intercom call.</li> </ul>
10	MUTE key	Turns the loudspeaker on or off.

## 6. REMOTE HANDSET

No.	Control	Function
11	MENU key	Opens/closes the menu.
12	0 to 9 keys	<ul style="list-style-type: none"> <li>Enters the channel on the RT screen.</li> <li>Selects the menu items.</li> </ul>
13	CONTRAST key	<p><b>Short press:</b> Opens the contrast setup screen. Press the ▲ or ▼ key to adjust the contrast.</p> <p><b>Long press (more than three seconds):</b> Restores the contrast to the default setting.</p>
14	BRILL key	Opens the BRILL setup screen. Press the ▲ or ▼ key to adjust the BRILL. You can also use the <b>BRILL</b> key.

## 6.2 How to Turn On/Off the Power

A handset does not have a power key. Turn on or off the power from the transceiver unit.

## 6.3 Radiotelephone (RT) Screen

Below are the radiotelephone (RT) screens on the remote handset.

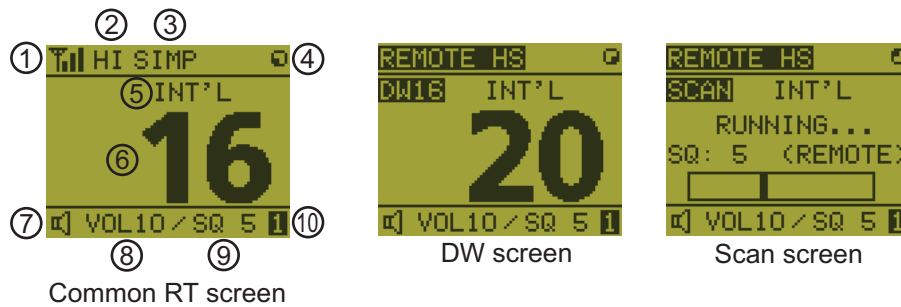

When no terminal has operation rights and a remote handset is off hook, this screen appears.

A remote handset can get operation rights immediately by hooking on then hooking off. (The operation right means that the terminal gets the right to use its functions.)

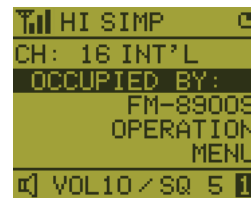

When other terminal is operated

No.	Meaning
1	RX signal strength (This icon does not appear while transmitting.)
2	Output power ([HI]: High, [LO]: Low)
3	Channel type ([SIMP]: Simplex, [DUP]: Duplex)
4	Spinner rotates when the equipment is functioning normally.
5	Channel region ([INT'L], [USA], [CANADA], [INLAND-W], [PRIVATE])
6	Channel
7	Loudspeaker on ( [L] ) or off ( [R] )
8	Volume for loudspeaker (0 to 10)
9	Squelch level (0 to 10, AUTO (Indication is [SQA].))
10	Terminal ID ([L]: Left wing handset, [R]: Right wing handset, [1] to [4]: Remote handset 1 to 4)

## 6.4 How to Adjust the Brilliance and Contrast

You can adjust the brilliance of the display and the panel for each remote handset separately. Also, you can adjust the contrast for each remote handset.

### **Brilliance**

1. Press the **BRILL** key to show the [BRILL] setting window.
2. Press the **▲** or **▼** key to adjust the brilliance.
3. Press the **ENTER** key to save the settings and close the window. To cancel the settings, press the **CANCEL** key instead of the **ENTER** key to close the window.

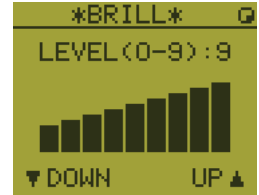

**Note:** The [BRILL] setting window automatically closes when there is no operation for three seconds.

### Contrast

1. Press the **CONTRAST** key to show the [CONTRAST] setting window.
2. Press the **▲** or **▼** key to adjust the contrast.
3. Press the **ENTER** key to save the settings and close the window. To cancel the settings, press the **CANCEL** key instead of the **ENTER** key to close the window.



**Note:** The [CONTRAST] setting window automatically closes when there is no operation for three seconds.

## 6.5 How to Select the Channel Region, Channel

### Channel region

1. Press the **MENU** key to open the [MENU] screen.
2. Press the **▲** or **▼** key to select [REGION] then press the **ENTER** key.

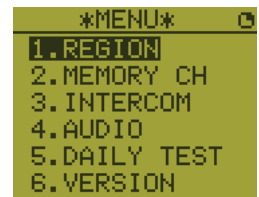

3. Press the **▲** or **▼** key to select the channel mode desired then press the **ENTER** key. The following modes are available.
  - [INT'L]: International mode
  - [USA]: USA mode
  - [CANADA]: CANADA mode
  - [INLAND-W]: Inland waterway mode
  - [PRIVATE]: Private channel

**Note 1:** Only permitted channel regions are displayed, which are set by the installer of the equipment.

**Note 2:** Private channels are available only where permitted by the authorities. The [USA], [CANADA], [INLAND-W], [PRIVATE] can also be set by a qualified service technician.

### **Channel**

The channel can be set manually on the RT screen. Enter the channel by one of the methods below.

Enter channel with the ▲ or ▼ key:

Press the ▲ or ▼ key on the RT screen.

Enter channel with the numeric keys:

Use the numeric keys to enter channel on the RT screen. (It is not necessary to press the **ENTER** key after entering the channel; the setting is confirmed one second after it is entered.)

**Note:** When the transceiver unit is in on hook condition, you can change the channel with the remote handset.

### **Memory channel**

You can easily call up a channel which you registered in the transceiver unit as a memory channel (see section 5.4).

1. Press the **MENU** key to open the [MENU] screen.
2. Press the ▲ or ▼ key to select [MEMORY CH] then press the **ENTER** key.
3. Press the ▲ or ▼ key to select [ON] or [OFF] then press the **ENTER** key. When you select [ON], "M" appears on the screen. On the RT screen, you can select a memory channel by pressing the ▲ or ▼ key. The following figure shows the example for CH 10.

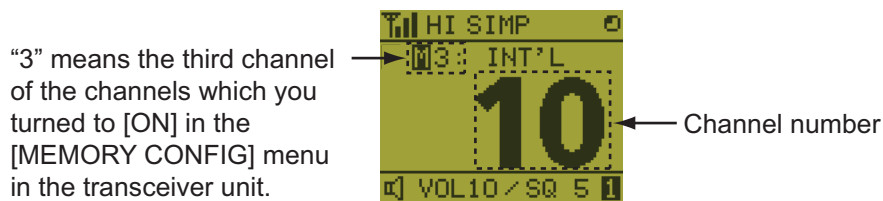

## **6.6 Transmission**

### **How to transmit**

Press the **PTT** (Push-to-talk) switch on the handset to talk, and release it to listen for a response. "TX" appears at the top left-hand corner of the screen during transmission.

**Note 1:** The **PTT** switch is unavailable when other terminal has operation right or a remote handset is on hook.

**Note 2:** When there is no indication for channel number on the screen, you can not transmit even if you press the **PTT** switch.

### How to change the output power

Press the **HI/LO** key to change the output power to high and low alternately. "HI" or "LO" appears on the screen depending on your selection.

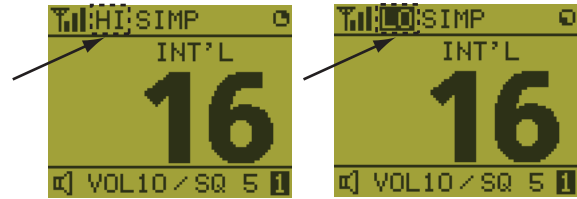

## 6.7 How to Turn On/Off the Loudspeaker

You can turn the loudspeaker (other than DSC communication, alert, and key beep) on or off.

1. Press the **SPK** key to alternately disable or enable the loudspeaker.



Speaker ON



Speaker OFF

2. To adjust the volume of the loudspeaker, press the **VOL** key. The screen changes as below.

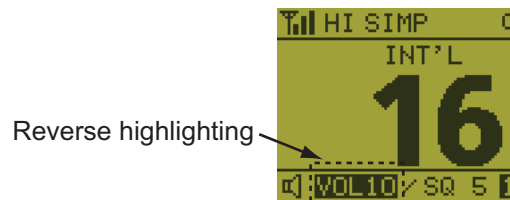

3. Press the **▲** or **▼** key to adjust the volume during reverse highlighting. The time for reverse highlighting is three seconds.

## 6.8 Quick Selection of CH16

Press the **CH16** key to select CH16. The CH16 (156.8 MHz) is the international frequency for distress traffic and for calling by radiotelephone. The CH16 can also be used by ship stations for call and reply. To facilitate the reception of distress calls and distress traffic, all transmissions on CH16 should be kept to a minimum and should not exceed one minute. Before transmitting on the CH16, a station should listen on this frequency for a reasonable period to make sure that no distress traffic is being sent.

## 6.9 Intercom

The built-in intercom permits voice communications between two control units. The combination of two controls is transceiver unit & remote handset, or remote handset & remote handset.

### Calling

You can call over the intercom only in off hook condition.

1. Press the **MENU** key to open the [MENU] screen.

## 6. REMOTE HANDSET

2. Press the ▲ or ▼ key to select [INTERCOM] then press the **ENTER** key.
3. Press the ▲ or ▼ key to select the called party's terminal then press the **ENTER** key.  
The called party's terminal and yours ring.  
To cancel calling, press the **CANCEL** key.
4. When the called party answers your call, the screen as shown in the right figure appears. Start communications.  
**Note:** You do not have to press the **PTT** switch during communication.
5. Hang up the handset or press the **CANCEL** or the **CH16** key to turn the intercom off. The RT screen appears.

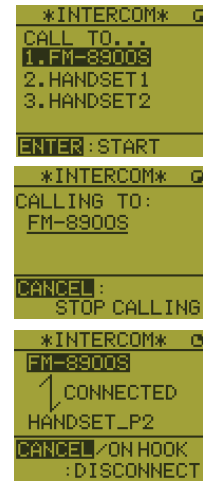

### Answering

1. The terminal rings and the following screen appears. To cancel reply, press the **CANCEL** key.



2. Press the **ENTER** key with off hook condition or pick up the handset with on hook condition to start communications.
3. Hang up the handset or press the **CANCEL** key to turn the intercom off. The RT screen appears.

### Earpiece volume

You can adjust the volume of the earpiece during intercom communication by pressing the ▲ or ▼ key. After intercom communication, the earpiece volume is reverted to the setting value you set on [EARPIECE LEVEL] (see section 6.11).

**Note:** Neither key click nor key error sounds during intercom communication.

## 6.10 How to Change the Terminal ID

1. Turn off the remote handset by the transceiver unit.
2. While you hold the **MENU** key, turn on the remote handset by the transceiver unit. The setting window for terminal ID appears.
3. Enter the terminal ID, using the **1** to **6** keys, then press the **ENTER** key. Do not assign the same number to multiple remote handsets. If the handset is used as a wing handset, assign terminal ID 5 to the left-side handset and terminal ID 6 to the right-side handset.
4. Disconnect the handset from the terminal, then reconnect the handset to complete the setup procedure.

**Note:** You can also restart the FM-8900S unit to complete the setup procedure.



## 6.11 Audio setting

The [AUDIO] menu enables or disables key beep and adjusts the volume of the earpiece and off hook loudspeaker.

### Key click

1. Press the **MENU** key to open the [MENU] screen.
2. Press the **▲** or **▼** key to select [AUDIO] then press the **ENTER** key.



3. Press the **▲** or **▼** key to select [KEY CLICK VOLUME] then press the **ENTER** key.

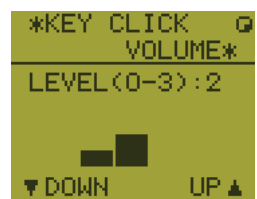

4. Press the **▲** or **▼** key to set the key click level (setting range: 0 (OFF), 1, 2 or 3).
5. Press the **ENTER** key. To cancel the setting, press the **CANCEL** key.

### Earpiece volume

1. Press the **MENU** key to open the [MENU] screen.
2. Press the **▲** or **▼** key to select [AUDIO] then press the **ENTER** key.
3. Press the **▲** or **▼** key to select [EARPIECE LEVEL] then press the **ENTER** key.

**Note:** Neither key click nor key error sounds during the [EARPIECE LEVEL] display.



4. Press the **▲** or **▼** key to set the earpiece volume level (setting range: 1 to 3).
5. Press the **ENTER** key. To cancel the setting, press the **CANCEL** key.

### Off hook loudspeaker

You can set the loudspeaker on or off according to off hook condition.

1. Press the **MENU** key to open the [MENU] screen.
2. Press the **▲** or **▼** key to select [AUDIO] then press the **ENTER** key.
3. Press the **▲** or **▼** key to select [OFF HOOK SPEAKER] then press the **ENTER** key.

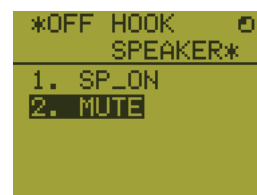

4. Press the **▲** or **▼** key to select [SP\_ON] or [MUTE].  
[SP\_ON]: Loudspeaker is activated when off hook.  
[MUTE]: Loudspeaker is deactivated when off hook.
5. Press the **ENTER** key. To cancel the setting, press the **CANCEL** key.

## 6.12 How to Test FM-8900S from a Remote Handset

1. Press the **MENU** key to open the [MENU] screen.
2. Press the **▲** or **▼** key to select [DAILY TEST] then press the **ENTER** key.



3. Press the **ENTER** key to start the test. You can confirm the test results for FM-8900S with the **1** or **3** key.

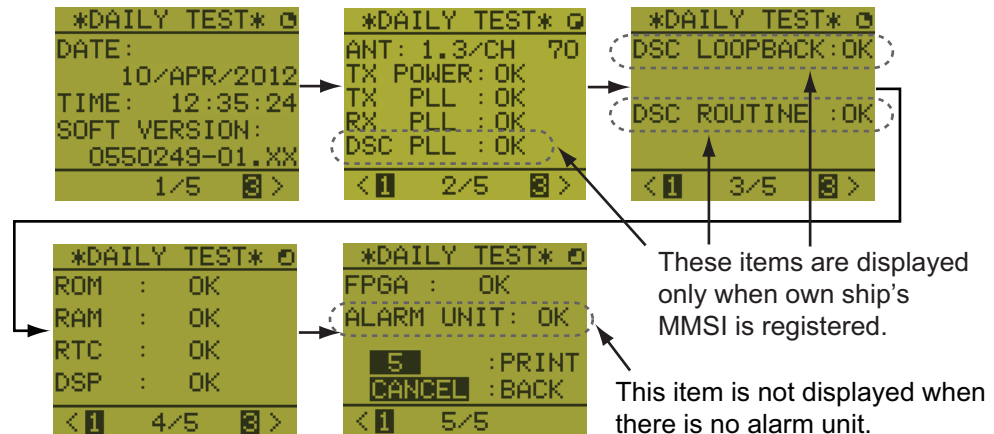

Press the **3** key for the next page and the **1** key for the previous page.

## 6.13 How to Display the Program Versions

1. Press the **MENU** key to open the [MENU] screen.
2. Press the **▲** or **▼** key to select [VERSION] then press the **ENTER** key. The program versions for FM-8900S and HS-8900 appear.

## 6.14 Squelch

- The squelch value is common to all remote handsets. If you change a squelch value for a remote handset, squelch values for all other remote handsets are changed accordingly.
- You can not change a squelch value for a remote handset while the squelch is being adjusted by another remote handset.
- When the DW or scan is active, the squelch value from the terminal (transceiver unit or remote handset) that initiated the DW or scan is used.

# 7. MAINTENANCE & TROUBLESHOOTING

**WARNING**

**ELECTRICAL SHOCK HAZARD**  
Do not open the equipment.

Only qualified personnel should work inside the equipment.

**NOTICE**

Do not apply paint, anti-corrosive sealant or contact spray to plastic parts or equipment coating.

Those items contain products that can damage plastic parts and equipment coating.

## 7.1 Daily Test

Do the daily test to check the radiotelephone for proper operation.

Rotate the **CHANNEL/ENTER** knob to select [TEST] on the [MENU] screen then push the knob. The daily test starts. After the test is completed, the audio alarm sounds and the screen shown below appears. This screen shows:

- Test date
- Program version number
- Test results for TX power, TX PLL, RX PLL, DSC PLL, DSC LOOPBACK, DSC ROUTINE, ROM, RAM, RTC, DSP, FPGA and alarm unit (only when connecting the alarm unit), shown as [OK] or [NG] (No Good). For NG, contact your dealer for advice. The DSC ROUTINE test checks, using a DSC signal, the encode and decode functions of the signal processor.

If the displayed value greatly increases compared with the previous value, the antenna may be damaged. Refer to section 7.2 for maintenance guidance.

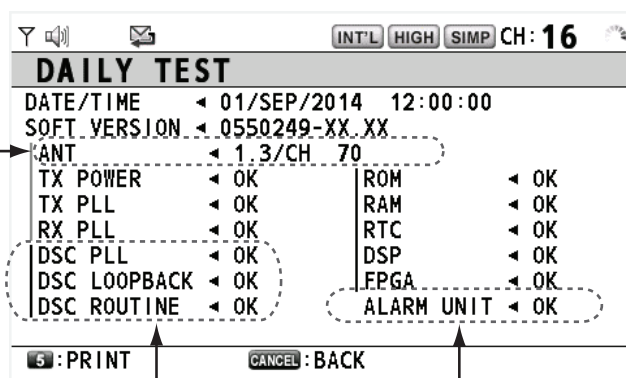

These items are not available when own ship's MMSI is not entered.

This item is not available when not connecting the alarm unit.

To print out the test result manually, press the **5** key. Automatic printing of the daily test is available. See section 5.5.

## 7.2 Maintenance

Regular maintenance helps to keep your equipment in good condition and prevents future problems. Check the items shown in the table below.

Item	Check point	Remedy/Remarks
Antenna	Check for physical damage and corrosion.	Replace damaged parts.
Transceiver unit	<ul style="list-style-type: none"> <li>• Check ground connection.</li> <li>• Check connection at signal cable, coaxial cable, control cable, power cable and external equipment (including navigator).</li> <li>• Confirm that there are no objects on the top of the transceiver unit.</li> <li>• Remove dust from transceiver unit with soft cloth.</li> </ul> <p><b>Note:</b> Do not use chemical cleaners to clean the transceiver unit; they can remove paint or markings and deform the equipment.</p>	<ul style="list-style-type: none"> <li>• Tighten the loosened connections; remove foreign materials from connectors.</li> <li>• Remove any objects.</li> <li>• Wipe the LCD carefully to prevent scratching, using tissue paper and an LCD cleaner. To remove dirt or salt deposits, use an LCD cleaner, wiping slowly with tissue paper so as to dissolve the dirt or salt. Change paper frequently so the salt or dirt does not scratch the LCD.</li> </ul>
Power supply	Check that the supply voltage at transmission is within the rated range (21.6 to 31.2 VDC at the power connector).	If not within the range, check power source. Low voltage may cause erratic operation.
Power fuse	Check if a power fuse (7A) has blown.	If the fuse has blown, find out the cause before replacing it (Type: FGBO 125V 7A PBF). If it blows after replacement, contact your dealer.

## 7.3 Simple Troubleshooting

The table below provides possible problems and the means with which to restore normal operation. If normal operation cannot be restored, do not attempt to check inside the equipment. Any servicing should be referred to a qualified technician.

Problem	Probable cause	Remedy
Power cannot be turned on.	<ul style="list-style-type: none"> <li>• Mains switchboard is off.</li> <li>• (DC) voltage is too high or too low.</li> <li>• Battery has discharged, or poor contact at terminals.</li> </ul>	<ul style="list-style-type: none"> <li>• Turn on the mains switchboard.</li> <li>• Check supply voltage.</li> <li>• Recharge the battery and tighten the battery terminals.</li> </ul>
Display indications do not appear.	Display brilliance is too low.	Press the <b>BRILL</b> key to adjust the display brilliance.
Power is on but no sound from the main speaker.	Main speaker is off.	Press the  key to turn on the main speaker.
Output power reduced to LOW	Power is automatically reduced to protect against overheating due to continuous transmission.	Wait until the unit cools.

## 7.4 Test Call

This function sends a DSC test message to a coast or ship station. For that reason, it should not be executed unnecessarily. You can prepare a test call beforehand (see subsection 5.14.5).

- 1) Press the **OTHER DSC MSG** key to open the [COMPOSE MESSAGE].
- 2) Rotate the **CHANNEL/ENTER** knob to select [MSG TYPE] then push the knob.
- 3) Rotate the **CHANNEL/ENTER** knob to select [TEST MSG] then push the knob. [PRIORITY] is automatically set to [SAFETY].
- 4) With [TO] selected, push the **CHANNEL/ENTER** knob.
- 5) Rotate the **CHANNEL/ENTER** knob to select [DIRECT INPUT], [ADDRESS BOOK DATA] or [AIS TARGET DATA] then push the knob.  
 [DIRECT INPUT]: Enter the MMSI of the station where to send the call then push the **CHANNEL/ENTER** knob.  
 [ADDRESS BOOK DATA]: Select an MMSI from the [ADDRESS BOOK] (see section 5.13) then push the **CHANNEL/ENTER** knob.  
 [AIS TARGET DATA]: Select an MMSI from the [AIS TARGET LIST] then push the **CHANNEL/ENTER** knob.
- 6) With [GO TO CALL] selected, push the **CHANNEL/ENTER** knob to send the test message. The screen is changed to the one for transmission. After the call is sent, the equipment waits for acknowledgment of the call. The timer starts counting up the time to wait for acknowledgment.
- 7) Do one of the following.

### **Test acknowledge message received**

The audio alarm sounds and the message "TEST ACK received! [CANCEL]: Stop alarm" appears. Press the **CANCEL** key to silence the alarm.

### **No response**

**Re-send call:** Rotate the **CHANNEL/ENTER** knob to select [RESEND] in the user options area then push the knob.

**Cancel call:** Rotate the **CHANNEL/ENTER** knob to select [QUIT] in the user options area then push the knob. The message shown in the right figure appears.

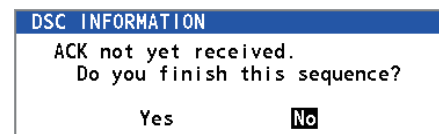

Rotate the **CHANNEL/ENTER** knob to select [Yes] then push the knob.

## 7. MAINTENANCE & TROUBLESHOOTING

This page is intentionally left blank.

# APPX. 1 MENU TREE

## Transceiver unit FM-8900S

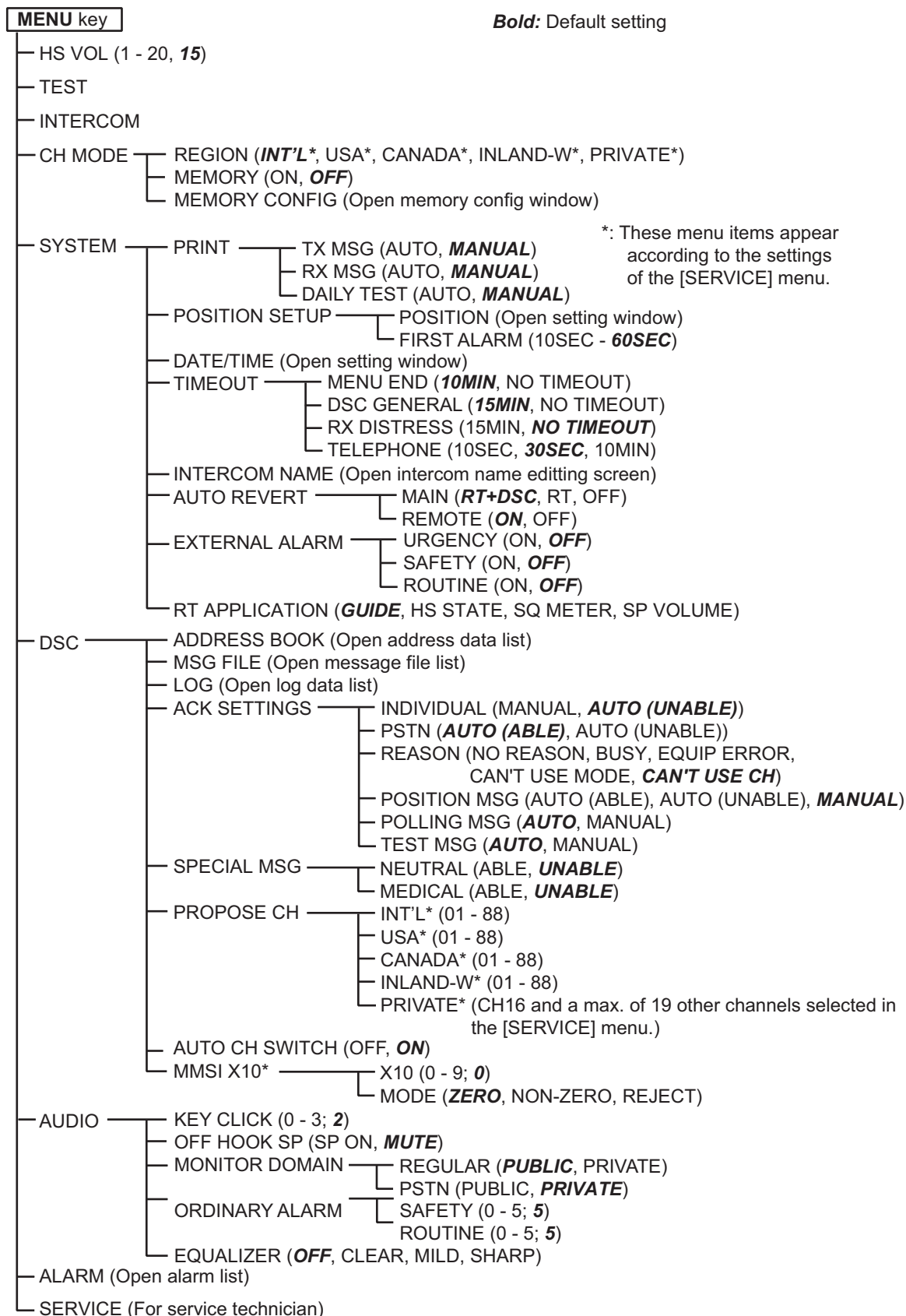

Remote handset HS-8900(-W)

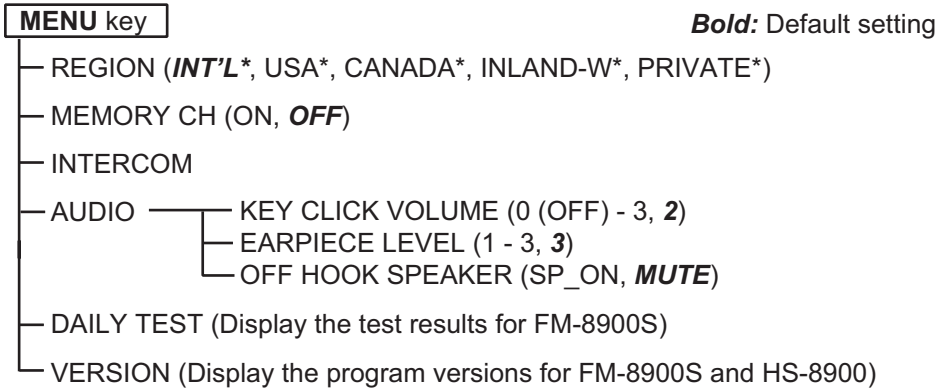

\*: These menu items appear according to the setting of the [SERVICE] menu in the FM-8900S.



# APPX. 2 MARINE VHF CHANNEL LISTS

**Note:** When setting channels and channel accessibility, check the local authority rulings to ensure each channel is set correctly. The contents of the tables below are correct at the time of printing, however local authorities can change channel access policies without prior notice.

The international channels table lists the channels in order of frequency.

## International (INT' L)

CH	TX (MHz)	RX (MHz)	Remarks	CH	TX (MHz)	RX (MHz)	Remarks
01	156.050	160.650	-	60	156.025	160.625	-
02	156.100	160.700	-	61	156.075	160.675	-
03	156.150	160.750	-	62	156.125	160.725	-
04	156.200	160.800	-	63	156.175	160.775	-
05	156.250	160.850	-	64	156.225	156.825	-
06	156.300	156.300	-	65	156.275	156.875	-
07	156.350	160.950	-	66	156.325	160.925	-
08	156.400	156.400	-	67	156.375	156.375	-
09	156.450	156.450	-	68	156.425	156.425	-
10	156.500	156.500	-	69	156.475	156.475	-
11	156.550	156.550	-	70	156.525	156.525	DSC
12	156.600	156.600	-	71	156.575	156.575	-
13	156.650	156.650	-	72	156.625	156.625	-
14	156.750	156.750	-	73	156.725	156.725	-
15	156.700	156.700	-	74	156.675	156.675	-
16	156.800	156.800	-	75	156.775	156.775	Low PWR
17	156.850	156.850	-	76	156.825	156.825	Low PWR
18	156.900	161.500	-	77	156.875	156.875	-
19	156.950	161.550	-	78	156.925	161.525	-
20	157.000	161.600	-	79	156.975	161.575	-
21	157.050	161.650	-	80	157.025	161.625	-
22	157.100	161.700	-	81	157.075	161.675	-
23	157.150	161.750	-	82	157.125	161.725	-
24	157.200	161.800	-	83	157.175	161.775	-
25	157.250	161.850	-	84	157.225	161.825	-
26	157.300	161.900	-	85	157.275	161.875	-
27	-	-	-	86	157.325	161.925	-
28	-	-	-	87	157.375	157.375	-
				88	157.425	157.425	-
1019	156.950	156.950	-	2019	(161.550)	161.550	RX only
1020	157.000	157.000	-	2020	(161.600)	161.600	RX only
1078	156.925	156.925	-	2078	(161.525)	161.525	RX only
1079	156.975	156.975	-	2079	(161.575)	161.575	RX only
1027	157.350	157.350	-				
1028	157.400	157.400	-				

APPX. 2 MARINE VHF CHANNEL LISTS

USA channels

CH	TX (MHz)	RX (MHz)	Remarks	CH	TX (MHz)	RX (MHz)	Remarks
1001	156.050	156.050	-	60	-	-	-
02	-	-	-	61	-	-	-
03	-	-	-	62	-	-	-
04	-	-	-	1063	156.175	156.175	-
1005	156.250	156.250	-	64	-	-	-
06	156.300	156.300	-	1065	156.275	156.275	-
1007	156.350	156.350	-	1066	156.325	156.325	-
08	156.400	156.400	-	67	156.375	156.375	Low PWR
09	156.450	156.450	-	68	156.425	156.425	-
10	156.500	156.500	-	69	156.475	156.475	-
11	156.550	156.550	-	70	156.525	156.525	DSC
12	156.600	156.600	-	71	156.575	156.575	Low PWR
13	156.650	156.650	Low PWR	72	156.625	156.625	-
14	156.700	156.700	-	73	156.675	156.675	-
15	-	156.750	-	74	156.725	156.725	-
16	156.800	156.800	-	75	-	-	-
17	156.850	156.850	Low PWR	76	-	-	-
1018	156.900	156.900	-	77	156.875	156.875	Low PWR
1019	156.950	156.950	-	1078	156.925	156.925	-
20	157.000	161.600	-	1079	156.975	156.975	-
1020	157.000	157.000	-	1080	157.025	157.025	-
1021	157.050	157.050	*	1081	157.075	157.075	*
1022	157.100	157.100	-	1082	157.125	157.125	*
1023	157.150	157.150	*	1083	157.175	157.175	*
24	157.200	161.800	-	84	157.225	161.825	-
25	157.250	161.850	-	85	157.275	161.875	-
26	157.300	161.900	-	86	157.325	161.925	-
27	157.350	161.950	-	87	157.375	157.375	-
28	157.400	162.000	-	88	157.425	157.425	-
-	-	-	-				

\*: USCG (United States Coast Guard) only (General use prohibited)

USA weather channels

WX	RX (MHz)	WX	RX (MHz)
01	162.550	06	162.500
02	162.400	07	162.525
03	162.475	08	161.650
04	162.425	09	161.775
05	162.450	10	163.275

Canadian channels

CH	TX (MHz)	RX (MHz)	Remarks	CH	TX (MHz)	RX (MHz)	Remarks
01	156.050	160.650	-	60	156.025	160.625	-
02	156.100	160.700	-	1061	156.075	156.075	*3
03	156.150	160.750	-	1062	156.125	156.125	*3
1004	156.200	156.200	*3	1063	156.175	156.175	*3
1005	156.250	156.250	*3	64	156.225	160.825	-
06	156.300	156.300	-	1064	156.225	156.225	*3
1007	156.350	156.350	*3	1065	156.275	156.275	*3
08	156.400	156.400	-	1066	156.325	156.325	*3
09	156.450	156.450	-	67	156.375	156.375	-
10	156.500	156.500	-	68	156.425	156.425	-
11	156.550	156.550	-	69	156.475	156.475	-
12	156.600	156.600	-	70	156.525	156.525	DSC
13	156.650	156.650	-	71	156.575	156.575	-
14	156.700	156.700	-	72	156.625	156.625	-
15	156.750	156.750	Low PWR	73	156.675	156.675	-
16	156.800	156.800	-	74	156.725	156.725	-
17	156.850	156.850	Low PWR	75	156.775	156.775	Low PWR
1018	156.900	156.900	*3	76	156.825	156.825	Low PWR
1019	156.950	156.950	*3	77	156.875	156.875	-
20	157.000	161.600	Low PWR	1078	156.925	156.925	*3
1021	157.050	157.050	*1, *3	1079	156.975	156.975	*3
2021	-	161.650	*4	1080	157.025	157.025	*3
1022	157.100	157.100	*2, *3	1081	157.075	157.075	*1, *3
23	157.150	161.750	-	1082	157.125	157.125	*1, *3
2023	-	161.750	*4	1083	157.175	157.175	*3
24	157.200	161.800	-	2083	-	161.775	*1, *4
25	157.250	161.850	-	84	157.225	161.825	-
2025	-	161.850	*4	85	157.275	161.875	-
26	157.300	161.900	-	86	157.325	161.925	-
27	157.350	161.950	-	87	157.375	157.375	-
28	157.400	162.000	-	88	157.425	157.425	-
2028	-	162.000	*4				

\*1: DFO/Canadian Coast Guard only

\*2: For communications between the Coast Guard and non-Coast Guard stations only

\*3: CH10xx is equivalent to the Canadian CHxxA channel

\*4: CH20xx is equivalent to the Canadian CHxxB channel

Canadian weather channels

WX	RX (MHz)	WX	RX (MHz)
01	162.550	06	162.500
02	162.400	07	162.525
03	162.475	08	161.650
04	162.425	09	161.775
05	162.450	10	163.275

APPX. 2 MARINE VHF CHANNEL LISTS

Inland waterways (INLAND-W) channels

CH	TX (MHz)	RX (MHz)	Remarks	CH	TX (MHz)	RX (MHz)	Remarks
01	156.050	160.650	-	60	156.025	160.625	-
02	156.100	160.700	-	61	156.075	160.675	-
03	156.150	160.750	-	62	156.125	160.725	-
04	156.200	160.800	-	63	156.175	160.775	-
05	156.250	160.850	-	64	156.225	160.825	-
06	156.300	156.300	Low PWR	65	156.275	160.875	-
07	156.350	160.950	-	66	156.325	160.925	-
08	156.400	156.400	Low PWR	67	156.375	156.375	-
09	156.450	156.450	-	68	156.425	156.425	-
10	156.500	156.500	Low PWR	69	156.475	156.475	-
11	156.550	156.550	Low PWR	70	156.525	156.525	DSC
12	156.600	156.600	Low PWR	71	156.575	156.575	Low PWR
13	156.650	156.650	Low PWR	72	156.625	156.625	Low PWR
14	156.700	156.700	Low PWR	73	156.675	156.675	-
15	156.750	156.750	Low PWR	74	156.725	156.725	Low PWR
16	156.800	156.800	-	75	156.775	156.775	Low PWR
17	156.850	156.850	Low PWR	76	156.825	156.825	Low PWR
18	156.900	161.500	-	77	156.875	156.875	Low PWR
19	156.950	161.550	-	78	156.925	161.525	-
1019	156.950	156.950	-	1078	156.925	156.925	-
2019	-	161.550	RX only	2078	-	161.525	RX only
20	157.000	161.600	-	79	156.975	161.575	-
1020	157.000	157.000	-	1079	156.975	156.975	-
2020	-	161.600	RX only	2079	-	161.575	RX only
21	157.050	161.650	-	80	157.025	161.625	-
22	157.100	161.700	-	81	157.075	161.675	-
23	157.150	161.750	-	82	157.125	161.725	-
24	157.200	161.800	-	83	157.175	161.775	-
25	157.250	161.850	-	84	157.225	161.825	-
26	157.300	161.900	-	85	157.275	161.875	-
27	-	-	-	86	157.325	161.925	-
1027	157.350	157.350	-	87	157.375	157.375	-
28	-	-	-	88	157.425	157.425	-
1028	157.400	157.400	-	-	-	-	-

Private channels

TX (MHz) Simplex/Semi-duplex	RX (MHz)		CH no. (current)	Remarks
	Simplex	Semi-duplex		
155.000	155.000	159.600	180	-
155.025	155.025	159.625	181	-
155.050	155.050	159.650	182	-
155.075	155.075	159.675	183	-
155.100	155.100	159.700	184	-
155.125	155.125	159.725	185	-
155.150	155.150	159.750	186	-
155.175	155.175	159.775	187	-
155.200	155.200	159.800	188	-
155.225	155.225	159.825	189	-
155.250	155.250	159.850	190	-
155.275	155.275	159.875	191	-
155.300	155.300	159.900	192	-
155.325	155.325	159.925	193	-
155.350	155.350	159.950	194	-
155.375	155.375	159.975	195	-
155.400	155.400	160.000	196	-
155.425	155.425	160.025	197	-
155.450	155.450	160.050	198	-
155.475	155.475	160.075	199	-
155.500	155.500	160.100	120(L1)	-
155.525	155.525	160.125	121(L2)	-
155.550	155.550	160.150	122	-
155.575	155.575	160.175	123	-
155.600	155.600	160.200	124	-
155.625	155.625	160.225	125(F1)(P1)	-
155.650	155.650	160.250	126(L3)	-
155.675	155.675	160.275	127	-
155.700	155.700	160.300	128	-
155.725	155.725	160.325	129	-
155.750	155.750	160.350	130	-
155.775	155.775	160.375	131(F2)(P2)	-
155.800	155.800	160.400	132	-
155.825	155.825	160.425	133(F3)(P3)	-
155.850	155.850	160.450	134	-
155.875	155.875	160.475	135	-
155.900	155.900	160.500	136	-
155.925	155.925	160.525	137	-
155.950	155.950	160.550	138	-
155.975	155.975	160.575	139	-

- Continued -

APPX. 2 MARINE VHF CHANNEL LISTS

TX (MHz) Simplex/Semi-duplex	RX (MHz)		CH no. (current)	Remarks
	Simplex	Semi-duplex		
156.000	156.000	160.600	00	-
156.025	156.025	160.625	60	-
156.050	156.050	160.650	01	-
156.075	156.075	160.675	61	-
156.100	156.100	160.700	02	-
156.125	156.125	160.725	62	-
156.150	156.150	160.750	03	-
156.175	156.175	160.775	63	-
156.200	156.200	160.800	04	-
156.225	156.225	160.825	64	-
156.250	156.250	160.850	05	-
156.275	156.275	160.875	65	-
156.300	156.300	160.900	06	-
156.325	156.325	160.925	66	-
156.350	156.350	160.950	07	-
156.375	156.375	160.975	67	-
156.400	156.400	161.000	08	-
156.425	156.425	161.025	68	-
156.450	156.450	161.050	09	-
156.475	156.475	161.075	69	-
156.500	156.500	161.100	10	-
156.525	156.525	161.125	70	-
156.550	156.550	161.150	11	-
156.575	156.575	161.175	71	-
156.600	156.600	161.200	12	-
156.625	156.625	161.225	72	-
156.650	156.650	161.250	13	-
156.675	156.675	161.275	73	-
156.700	156.700	161.300	14	-
156.725	156.725	161.325	74	-
156.750	156.750	161.350	15	-
156.775	156.775	161.375	75	-
156.800	156.800	161.400	16	-
156.825	156.825	161.425	76	-
156.850	156.850	161.450	17	-
156.875	156.875	161.475	77	-
156.900	156.900	161.500	18	-
156.925	156.925	161.525	78	-
156.950	156.950	161.550	19	-
156.975	156.975	161.575	79	-
157.000	157.000	161.600	20	-
157.025	157.025	161.625	80	-
157.050	157.050	161.650	21	-
157.075	157.075	161.675	81	-
157.100	157.100	161.700	22	-

- Continued -

TX (MHz) Simplex/Semi-duplex	RX (MHz)		CH no. (current)	Remarks
	Simplex	Semi-duplex		
157.125	157.125	161.725	82	-
157.150	157.150	161.750	23	-
157.175	157.175	161.775	83	-
157.200	157.200	161.800	24	-
157.225	157.225	161.825	84	-
157.250	157.250	161.850	25	-
157.275	157.275	161.875	85	-
157.300	157.300	161.900	26	-
157.325	157.325	161.925	86	-
157.350	157.350	161.950	27	-
157.375	157.375	161.975	87	-
157.400	157.400	162.000	28	-
157.425	157.425	162.025	88	-
157.450	157.450	162.050	29	-
157.475	157.475	162.075	89	-
157.500	157.500	162.100	30	-
157.525	157.525	162.125	90	-
157.550	157.550	162.150	31	-
157.575	157.575	162.175	91	-
157.600	157.600	162.200	32	-
157.625	157.625	162.225	92	-
157.650	157.650	162.250	33	-
157.675	157.675	162.275	93	-
157.700	157.700	162.300	34	-
157.725	157.725	162.325	94	-
157.750	157.750	162.350	35	-
157.775	157.775	162.375	95	-
157.800	157.800	162.400	36	-
157.825	157.825	162.425	96	-
157.850	157.850	162.450	37(M1)	-
157.875	157.875	162.475	97	-
157.900	157.900	162.500	38	-
157.925	157.925	162.525	98	-
157.950	157.950	162.550	39	-
157.975	157.975	162.575	99	-
158.000	158.000	162.600	40	-
158.025	158.025	162.625	100	-
158.050	158.050	162.650	41	-
158.075	158.075	162.675	101	-
158.100	158.100	162.700	42	-
158.125	158.125	162.725	102	-
158.150	158.150	162.750	43	-
158.175	158.175	162.775	103	-
158.200	158.200	162.800	44	-
158.225	158.225	162.825	104	-
158.250	158.250	162.850	45	-

- Continued -

APPX. 2 MARINE VHF CHANNEL LISTS

TX (MHz) Simplex/Semi-duplex	RX (MHz)		CH no. (current)	Remarks
	Simplex	Semi-duplex		
158.275	158.275	162.875	105	-
158.300	158.300	162.900	46	-
158.325	158.325	162.925	106	-
158.350	158.350	162.950	47	-
158.375	158.375	162.975	107	-
158.400	158.400	163.000	48	-
158.425	158.425	163.025	108	-
158.450	158.450	163.050	49	-
158.475	158.475	163.075	109	-
158.500	158.500	163.100	50	-
158.525	158.525	163.125	110	-
158.550	158.550	163.150	51	-
158.575	158.575	163.175	111	-
158.600	158.600	163.200	52	-
158.625	158.625	163.225	112	-
158.650	158.650	163.250	53	-
158.675	158.675	163.275	113	-
158.700	158.700	163.300	54	-
158.725	158.725	163.325	114	-
158.750	158.750	163.350	55	-
158.775	158.775	163.375	115	-
158.800	158.800	163.400	56	-
158.825	158.825	163.425	116	-
158.850	158.850	163.450	57	-
158.875	158.875	163.475	117	-
158.900	158.900	163.500	58	-
158.925	158.925	163.525	118	-
158.950	158.950	163.550	59	-
158.975	158.975	163.575	119	-
159.000	159.000	163.600	200	-
159.025	159.025	163.625	201	-
159.050	159.050	163.650	202	-
159.075	159.075	163.675	203	-
159.100	159.100	163.700	204	-
159.125	159.125	163.725	205	-
159.150	159.150	163.750	206	-
159.175	159.175	163.775	207	-
159.200	159.200	163.800	208	-
159.225	159.225	163.825	209	-
159.250	159.250	163.850	210	-
159.275	159.275	163.875	211	-
159.300	159.300	163.900	212	-
159.325	159.325	163.925	213	-
159.350	159.350	163.950	214	-
159.375	159.375	163.975	215	-
159.400	159.400	164.000	216	-

- Continued -



TX (MHz) Simplex/Semi-duplex	RX (MHz)		CH no. (current)	Remarks
	Simplex	Semi-duplex		
159.425	159.425	164.025	217	-
159.450	159.450	164.050	218	-
159.475	159.475	164.075	219	-
159.500	159.500	164.100	220	-
159.525	159.525	164.125	221	-
159.550	159.550	164.150	222	-
159.575	159.575	164.175	223	-
159.600	159.600	164.200	224	-
159.625	159.625	-	225	-
159.650	159.650	-	226	-
159.675	159.675	-	227	-
159.700	159.700	-	228	-
159.725	159.725	-	229	-
159.750	159.750	-	230	-
159.775	159.775	-	231	-
159.800	159.800	-	232	-
159.825	159.825	-	233	-
159.850	159.850	-	234	-
159.875	159.875	-	235	-
159.900	159.900	-	236	-
159.925	159.925	-	237	-
159.950	159.950	-	238	-
159.975	159.975	-	239	-
160.000	160.000	-	240	-
160.025	160.025	-	241	-
160.050	160.050	-	242	-
160.075	160.075	-	243	-
160.100	160.100	-	244	-
160.125	160.125	-	245	-
160.150	160.150	-	246	-
160.175	160.175	-	247	-
160.200	160.200	-	248	-
160.225	160.225	-	249	-
160.250	160.250	-	250	-
160.275	160.275	-	251	-
160.300	160.300	-	252	-
160.325	160.325	-	253	-
160.350	160.350	-	254	-
160.375	160.375	-	255	-
160.400	160.400	-	256	-
160.425	160.425	-	257	-
160.450	160.450	-	258	-
160.475	160.475	-	259	-
160.500	160.500	-	140	-
160.525	160.525	-	141	-
160.550	160.550	-	142	-

- Continued -

APPX. 2 MARINE VHF CHANNEL LISTS

TX (MHz) Simplex/Semi-duplex	RX (MHz)		CH no. (current)	Remarks
	Simplex	Semi-duplex		
160.575	160.575	-	143	-
160.600	160.600	-	144	-
160.625	160.625	-	145	-
160.650	160.650	-	146	-
160.675	160.675	-	147	-
160.700	160.700	-	148	-
160.725	160.725	-	149	-
160.750	160.750	-	150	-
160.775	160.775	-	151	-
160.800	160.800	-	152	-
160.825	160.825	-	153	-
160.850	160.850	-	154	-
160.875	160.875	-	155	-
160.900	160.900	-	156	-
160.925	160.925	-	157	-
160.950	160.950	-	158	-
160.975	160.975	-	159	-
161.000	161.000	-	160	-
161.025	161.025	-	161	-
161.050	161.050	-	162	-
161.075	161.075	-	163	-
161.100	161.100	-	164	-
161.125	161.125	-	165	-
161.150	161.150	-	166	-
161.175	161.175	-	167	-
161.200	161.200	-	168	-
161.225	161.225	-	169	-
161.250	161.250	-	170	-
161.275	161.275	-	171	-
161.300	161.300	-	172	-
161.325	161.325	-	173	-
161.350	161.350	-	174	-
161.375	161.375	-	175	-
161.400	161.400	-	176	-
161.425	161.425	-	177(M2)	-
161.450	161.450	-	178	-
161.475	161.475	-	179	-

# APPX. 3 ABBREVIATIONS AND ICONS









## Abbreviations

Abbreviation	Term	Abbreviation	Term
ACK	Acknowledge	LAT	Latitude
AIS	Automatic Identification System	LO	Low
ALARM	Alarm	LOG	Log
AMS	Alert Management System	LON	Longitude
ANT	Antenna	LV	Level
APP	Application	MAR	March
APR	April	MEM	Memory
AUG	August	MENU	Menu
AUTO	Automatic	MIN	Minute(s)
BAM	Bridge Alert Management	MMSI	Maritime Mobile Services Identity
BAMS	Bridge Alert Management System	MOB	Man Overboard
BRILL	Brilliance	MSG	Message
CAM	Central Alert Management	MUTE	Mute
CAM-HMI	CAM-Human Machine Interface	N	North
CAN'T	Cannot	NAV	Navigation
CH	Channel	NG	No Good
COMM	Communication	NOV	November
CPU	Central Processing Unit	OCT	October
DATE	Date	OFF	Off
DEC	December	ON	On
DSC	Digital Selective Calling	PLL	Phase Locked Loop
DSP	Digital Signal Processor	PSTN	Public Switched Telephone Network
DUP	Duplex	PWR	Power
DW	Dual Watch	RAM	Random Access Memory
E	East	REF	Reference
ECC	Error Correction Code	RF	Radio Frequency
ENT	Enter	ROM	Read Only Memory
EPFS	Electronic Position Fixing System	RT	Radiotelephone
EQUIP	Equipment	RTC	Real Time Clock
FEB	February	RX	Receive
FPGA	Field Programmable Gate Array	S-DUP	Semi-Duplex
FREQ	Frequency	SEC	Second(s)
GMDSS	Global Maritime Distress and Safety System	SEP	September
GNSS	Global Navigation Satellite System	SIMP	Simplex
HI	High	SP	Speaker
HS	Handset	SQ	Squelch
INFO	Information	TIME	Time

Abbreviation	Term	Abbreviation	Term
INLAND-W	Inland Waterway	TRX	Transmit and Receive
INS	Integrated Navigation System	TX	Transmit
INTERCOM	Intercommunication System	USA	United States of America
INT'L	International	UTC	Coordinated Universal Time/ Universal Time, Coordinated
JAN	January	UTC	Voyage Data Recorder
JUN	June	VOL	Volume
JUL	July	WR	Watchkeeping Receiver

*Icons*

Icon	Meaning	Icon	Meaning
	Speaker ON.		Number keys.
	Speaker OFF.		<b>CHANNEL/ENTER</b> knob.
	Unread message.		Name of the ship registered in address book.
	Auto ACK for individual message is ON.		Name of the ship registered in AIS target list.
	Radio field intensity on the RT screen.		Data is being updated regularly.
	Radio field intensity on the screens except the RT screen.		Transmitting.
	Send a distress alert of your ship.		Channel region is INT'L.
	<ul style="list-style-type: none"> <li>Receive a distress alert from a ship in distress.</li> <li>Send a distress relay on behalf of a ship in distress.</li> </ul>		Channel region is USA.
	Send a general (safety, urgency or routine) message.		Channel region is WX.
	Receive a general (safety, urgency or routine) message.		Channel region is CANADA.
	Communicate via radiotelephone.		Channel region is INLAND-W.
	Equalizer mode is on.		Channel region is PRIVATE.
	Output power is high.		The memory channel is selected.
	Output power is low.		Dual watching.
	Simplex frequency.		Scanning.

Icon	Meaning	Icon	Meaning
	Duplex frequency.		Squelch is opened.
<i>Continued on following page.</i>			
	Distress frequency.		Active, unacknowledged alert.
	Active, silenced alert.		Rectified, unacknowledged alert.
	Active, acknowledged alert.		Active, caution.
	Active Responsibility Transferred to BAMS.		

# APPX. 4 DIGITAL INTERFACE

## Input Sentences (IEC 61162-1 compliant)

ACK, GGA, GLL, GNS, RMC, VDM, ZDA

### ***Input sentence description***

- ACK - Acknowledge alert

```
$**ACK,xxx*hh<CR><LF>
```

1

1. Unique alert ID at alert source

- GGA - Global positioning system (GPS) fix data

```
$**GGA,hhmmss.ss,llll.lll,a,yyyyy.yy,a,x,xx,x.x,x.x,M,x.x,M,x.x,xxxx*hh<CR><LF>
```

1 2 3 4 5 6 7 8 9 10 11 12 13 14

1. UTC of position (000000.00 - 235959.99)
2. Latitude (0000.0000 - 9000.0000)
3. N/S
4. Longitude (00000.0000 - 18000.0000)
5. E/W
6. GPS quality indicator (1 - 5)
7. Number of satellite in use (no use)
8. Horizontal dilution of precision (no use)
9. Antenna altitude above/below mean sealevel (no use)
10. Unit, m
11. Geoidal separation (no use)
12. Unit, m
13. Age of differential GPS data (no use)
14. Differential reference station ID (no use)

**Note:** For multiple position sensors, priority is based on the following:

- Talker: GN>GP>GA>GL>GB>GQ>GI>Others
- Formatter: GNS>GGA>RMC>GLL

When talker and formatter priorities are contradicting, formatter priority is selected.

- GLL - Geographic position - latitude/longitude

```
$**GLL,lll.ll,a,yyyyy.yy,a,hhmmss.ss,a,x*hh<CR><LF>
```

1 2 3 4 5 6 7

1. Latitude (0000.0000 - 9000.0000)
2. N/S
3. Longitude (00000.0000 - 18000.0000)
4. E/W
5. UTC of position (000000.00 - 235959.99)
6. Status (A=data valid V=data invalid)
7. Mode indicator (A=Autonomous, D=Differential)

**Note:** For multiple position sensors, priority is based on the following:

- Talker: GN>GP>GA>GL>GB>GQ>GI>Others
- Formatter: GNS>GGA>RMC>GLL

When talker and formatter priorities are contradicting, formatter priority is selected.

- GNS - GNSS fix data

```
$**GNS,hhmmss.ss,llll.ll,a,yyyyy.yy,a,c--c,xx,x.x,x.x,x.x,x.x,x.x,x.x,a*hh<CR><LF>
      1      2 3 4      5 6 7 8 9 10 11 12 13
```

1. UTC of position (000000.00 - 235959.99)
2. Latitude (0000.0000 - 9000.0000)
3. N/S
4. Longitude (00000.0000 - 18000.0000)
5. E/W
6. Mode indicator  
A=Autonomous D=Differential P=Precise R=Real Time Kinematic  
F=Float RTK
7. Total number of satellites in use (00 - 99)
8. HDOP (no use)
9. Antenna altitude, meters (no use)
10. Geoidal separation (no use)
11. Age of differential data (no use)
12. Differential reference station ID (no use)
13. Navigational status indicator (S=Safe C=Caution U=Unsafe V=Navigational status not valid)

**Note:** For multiple position sensors, priority is based on the following:

- Talker: GN>GP>GA>GL
- Formatter: GNS>GGA>RMC>GLL

When talker and formatter priorities are contradicting, formatter priority is selected.

- RMC - Recommended minimum specific GNSS data

```
$**RMC,hhmmss.ss,A,llll.ll,a,yyyyy.yy,a,x.x,x.x,ddmmyy,x.x,a,a*hh<CR><LF>
      1      2 3 4      5 6 7 8      9 10 11 12 13
```

1. UTC of position fix (000000.00 - 235959.99)
2. Status (A=data valid, V=navigation receiver warning)
3. Latitude (0000.0000 - 9000.0000)
4. N/S
5. Longitude (00000.0000 - 18000.0000)
6. E/W
7. Speed over ground, knots (no use)
8. Course over ground, degrees true (no use)
9. Date (010100 - 311249)
10. Magnetic variation, degrees (no use)
11. E/W
12. Mode indicator (A= Autonomous D= Differential  
F=Float RTK P=Precise R=Real time kinematic)
13. Navigational status indicator (S=Safe C=Caution U=Unsafe V=Navigational status not valid)

**Note:** For multiple position sensors, priority is based on the following:

- Talker: GN>GP>GA>GL>GB>GQ>GI>Others
- Formatter: GNS>GGA>RMC>GLL

When talker and formatter priorities are contradicting, formatter priority is selected.

APPX. 4 DIGITAL INTERFACE

- VDM - UAIS VHF data-link message

\$\*\*VDM,x,x,x,a,s--s,x,\*hh<CR><LF>  
           1 2 3 4 5 6

1. Total number of sentences needed to transfer the message (1 to 9)
2. Message sentence number (1 to 9)
3. Sequential message identifier (0 to 9, NULL)
4. AIS channel Number (A or B)
5. Encapsulated ITU-R M.1371 radio message (1 - 63 bytes)
6. Number of fill-bits (0 to 5)

- ZDA - Time and date

\$\*\*ZDA,hhmmss.ss,xx,xx,xxxx,xx,xx\*hh<CR><LF>  
           1     2 3 4 5 6

1. UTC (000000.00 - 235959.99)
2. Day (01 - 31)
3. Month (01 -12)
4. Year (2000 - 2049)
5. Local zone, hours (no use)
6. Loca zone, minutes (no use)

**Note:** The ZDA sentence is not received if the ZDA has the same talker as a position sentence (GGA, GLL, GNS, RMC) and the mode indicator of the position sentence is not a valid value.

Output Sentences (IEC 61162-1 compliant)

ALR, DSC, DSE, TLL

**Output sentence description**

- ALR - Set alarm state

\$CTALR,hhmmss,xxx,A,A,c--c\*hh<CR><LF>  
           1     2 3 4 5

1. Time of alert conditon change, UTC
2. Unique alert ID at alert source
3. Alert condition (A = threshold exceeded, V = not exceeded)
4. Alert's acknowledge atate (A = acknowledged, V - unacknowledged)
5. Alert's description text

Alert ID	Alert text
013	Position No Update
014	Position Lost
210	RX PLL UNLOCK
213	WR1 PLL UNLOCK
220	TX PLL UNLOCK
340	RF AMP Heated
500	Received DSC DISTRESS
510	Received DSC URGENCY
520	Received DSC SAFETY
530	Received DSC ROUTINE
620	Communication Error-RemoteHS
630	EPFS Error
730	Cannot Print



- DSC - Digital selective calling information

```
$CVDSC,xx,xxxxxxxxxx,xx,xx,xx,x.x,x.x,xxxxxxxxxx,xx,a,a*hh<CR><LF>
      1 2 3 4 5 6 7 8 9 10 11
```

1. Format specifier (2 digits)
2. Address (10 digits)
3. Category (2 digits or NULL)
4. Nature of Distress or first telecommand (2 digits or NULL)
5. Type of Communication or second telecommand (2 digits)
6. Position or Channel /Frequency (10 digits or 6 digits or NULL)\*
7. Time or Tel. No. (Max. 16 digits)
8. MMSI of ship in distress (10 digits or NULL)
9. Nature of distress (2 digits or NULL)
10. Acknowledgement (R=Acknowledge request B=Acknowledgement S=Neither (end of sequence))
11. Expansion indicator (E or NULL)

\*: If a NO INFO symbol is inserted in the output DSC message's DSC frequency field, NULL is output.

- DSE - Expanded digital selective calling

```
$CVDSE,x,x,a,xxxxxxxxxx,xx,c--c,.....,xx,c--c*hh<CR><LF>
      1 2 3 4 5 6 7 8 9
```

1. Total number of sentences (fixed value)
2. Sentence number (fixed value)
3. Query/reply flag (fixed value A=Automatic)
4. Vessel MMSI (10 digits)
5. Data set '1' (code field, fixed value 00)
6. Data set '1' (data field, Enhanced position resolution, Max. 8 characters), NULL
7. Additional data sets\*, NULL
8. Data set 'n' (NULL)\*
9. Data set 'n' (NULL)\*

\*: This equipment outputs only "Data set 1".

- TLL - Target latitude and longitude

```
$CVTLL,xx,llll.ll,a,yyyyy.yy,a,c--c,hhmmss.ss,a,a*hh<CR><LF>
      1 2 3 4 5 6 7 8 9
```

1. Target number, NULL
2. Latitude (0.0000 - 9000.0000)
3. N/S
4. Longitude (0.0000 - 18000.0000)
5. E/W
6. Target name, NULL
7. UTC of data (000000 - 235959)
8. Target status, NULL
9. Reference target, NULL

## Input Sentences

ACN, HBT

### **Input sentence description**

- ACN

```
$**ACN,hhmmss.ss,aaa,x.x,x.x,c,a*hh<CR><LF>  
      1      2 3 4 5 6
```

1. Time (UTC)
2. Manufacturer mnemonic code (3 digits)
3. Alert Identifier
4. Alert Instance (0 - 999999, NULL)
5. Alert command (A,Q,O,S)
  - A=acknowledge
  - Q=request/repeat information
  - O=responsibility transfer
  - S=silence
6. Sentence status flag

- HBT

```
$**HBT,x.x,A,x*hh<CR><LF>  
      1 2 3
```

1. Configured repeat interval (1 to 999, NULL)
2. Equipment status (A=Normal V=System fail)
3. Sequential sequence identifier (0 to 9)

## Output Sentences

ALC, ALF, ARC, HBT

### **Output sentence description**

- ALC

```
$CVALC,xx,xx,xx,x.x,aaa,x.x,x.x,x.x,"",*hh<CR><LF>  
      1 2 3 4 5 6 7 8 9
```

1. Total number of sentences this message (01 to 99)
2. Sentence number (01 to 99)
3. Sequential message identifier (00 to 99)
4. Number of alert entries
5. Manufacturer mnemonic code
6. Alert identifier
7. Alert instance
8. Revision counter
9. Additional alert entries (same as 5-8)

• ALF

\$CVALF,x,x,x,hhmmss.ss,a,a,a,aaa,x.x,x.x,x,x,c--c,\*hh<CR><LF>  
 1 2 3 4 5 6 7 8 9 10 11 12 13

1. Total number of ALF sentences this message (1, 2)
2. Sentence number (1, 2)
3. Sequential message identifier (0 to 9)
4. Time of last change \*
5. Alert category (A=Alert category A, B=Alert category B, C=Alert category C, NULL)
6. Alert priority (E=Emergency Alarm, A=Alarm, W=Warning, C=Caution, NULL)
7. Alert state
  - V=Active, unacknowledged
  - S=Active, silenced
  - A=Active, acknowledged(or active)
  - O=Active, responsibility transferred
  - U=Rectified, unacknowledged
  - N=Normal
  - NULL
8. Manufacturer mnemonic code
9. Alert identifier
10. Alert instance (0 to 999999, NULL)
11. Revision counter (1 to 99)
12. Escalation counter (0 to 9)
13. Alert text

\*: Temporary Silence and Silence Timeout do not update the time of last change. If the system time is out of sync with valid ZDA, NULL results (see section 5.7).

Alert identifier (*1)	Alert instance	Alert text (ALF 1st)	Alert text 2 (ALF 2nd)	Alert Priority	Alert Category	Sound
3013	NULL	POSITION:	No Position Update	Caution	B	DSC
610014	NULL	POSITION:	Position Lost	Caution	B	DSC
3008	0	TX POWER:	TX Multifunction	Warning	B	BAM
3008	1	TX POWER: INHIBIT	TX PLL UNLOCK	Warning	B	BAM
3008	2	TX POWER: FAILURE	RF AMP Heated	Warning	B	BAM
3115	0	Impaired radio	RX Multifunction	Warning	B	BAM
3115	1	Impaired radio	RX PLL UNLOCK	Warning	B	BAM
3115	2	Impaired radio	DSC PLL UNLOCK	Warning	B	BAM
3122	0	DISTRESS/URGENCY	Received DSC DISTRESS/URGENCY	Warning	A	
3122	1 to 7 *	DISTRESS: RX DISTRESS: RELAY	123456789 12-34N 123-45E 12:34 wait for ACK 123456789 12-34N 123-45E 12:34 ACK'ed 123456789 12-34N 123-45E 12:34 Canceled	Warning	A	DSC two-tone
3122	1 to 7 *	URGENCY: RX	CALL from 123456789 CH16 ACK from 123456789 CH16 UNABLE from 123456789 CH16 ACK' ed to 123456789 CH16	Warning	A	DSC two-tone
3123	0	SAFETY/ROUTINE	Received DSC SAFETY/ROUTINE	Caution	B	
3123	1 to 7 *	SAFETY: COM SAFETY: TEST SAFETY: POS	CALL from 123456789 CH16 CALL from 123456789	Caution	B	DSC telephone
3123	1 to 7 *	ROUTINE: COM ROUTINE: POLL	CALL from 123456789 CH16 CALL from 123456789	Caution	B	DSC telephone
3016	NULL	POSITION:	EPFS Error	Caution	B	DSC

Instance numbers listed with the “\*” annotation are dynamically assigned.

When more than one alert with the same Alert ID and different instance occur, the Aggregation Header Alert, which is assigned the instance “0”, is also output. Aggregation Header Alerts are used at the CAM-HMI to simplify the alert display.

“Alert text 2” contents are dynamic and vary depending on the DSC message’s ACK status, MMSI, vessel position and channel. Depending on the DSC transmission status, the contents may change. For the latest information, always check the FM-8900.

For DISTRESS messages, the MMSI is that of the vessel in distress; for all other messages, the MMSI is that of the sender.

Caution level alerts have no audible alert on the BAM, however, the DSC message beep sounds.

Warning level alerts are sounded with two short beeps on the BAM, however, DISTRESS and URGENCY messages release the DSC two-tone audible alarm.

Caution level alerts and category A Warning level alerts are not subject to responsibility transfer and cannot be remote acknowledged.

Warning can be temporarily silenced by inputting the ACN sentence.

- ARC

\$CVARC,hhmmss.ss,aaa,x.x,x.x,c\*hh<CR><LF>  
                  1   2   3   4   5

1. Release time of the Alert Command Refused(UTC)
2. Manufacturer mnemonic code
3. Alert identifier
4. The alert instance(1 to 999999, NULL)
5. Refused Alert Command(A, Q, O, S)  
    A=acknowledge  
    Q=request/repeat information  
    O=responsibility transfer  
    S=silence

- HBT

\$CVHBT,x.x,A,x\*hh<CR><LF>  
          1  2  3

1. Configured repeat interval (1 to 999, NULL)
2. Equipment status (A=Normal V=System fail)
3. Sequential sequence identifier (0 to 9)

### Proprietary sentences

pireq, pidat, CVdmr, CVdma

Schematic diagram

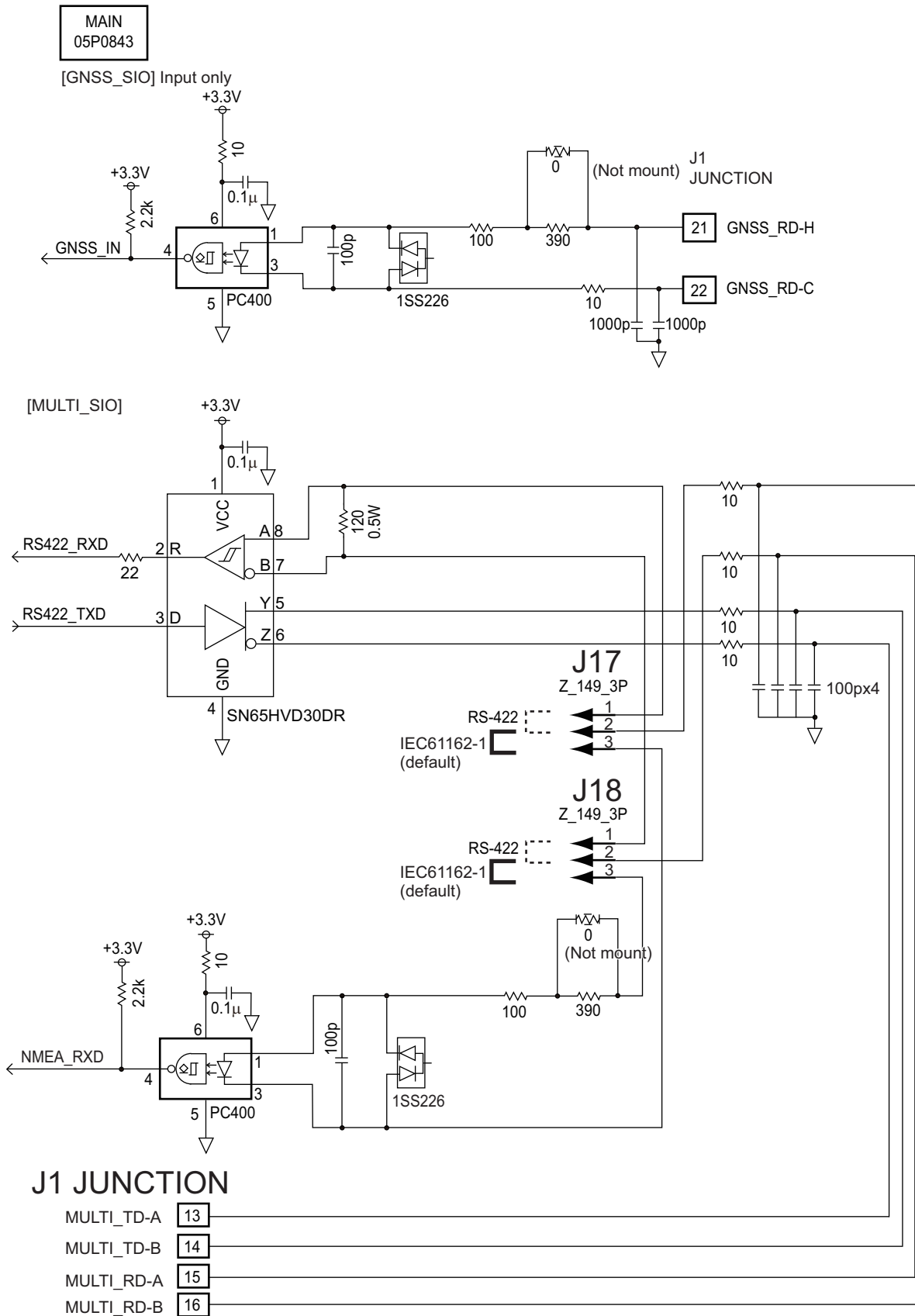

**Load requirements as a listener**

Isolation: Optocoupler    Input impedance: 430Ω    Max. voltage: ±15 V    Threshold: 4 mA

# APPX. 5 PARTS LIST

---

This equipment contains complex modules in which fault diagnosis and repair down to component level are not practical (IMO A.694(17)/8.3.1). Only some discrete components are used. FURUNO Electric Co., Ltd. Believes identifying these components is of no value for shipboard maintenance; therefore, they are not listed in this manual. Major modules can be located on the parts location photos on pages AP-21 thru AP-22.

## Transceiver Unit FM-8900S

<b>ELECTRICAL PARTS LIST</b>		Unit	Transceiver Unit FM-8900S
<b>PRINTED CIRCUIT BOARD</b>		<b>Code No.</b>	
05P0843, MAIN		—	
05P0841, TRX_WR		—	
05P0849, PWR		—	
05P0882, PANEL		—	

## Handset HS-2003

<b>ELECTRICAL PARTS LIST</b>		Unit	Handset HS-2003
<b>PRINTED CIRCUIT BOARD</b>		<b>Code No.</b>	
05P0780, HANDSET		—	

## Remote Handset HS-8900(-W)

<b>ELECTRICAL PARTS LIST</b>		Unit	Remote Handset HS-8900(-W)
<b>PRINTED CIRCUIT BOARD</b>		<b>Code No.</b>	
05P0781B, HS CONT		—	
05P0715, KEY		—	

## Remote Handset Hanger HG-8900(-W)

<b>ELECTRICAL PARTS LIST</b>		Unit	Remote Handset Hanger HG-8900(-W)
<b>PRINTED CIRCUIT BOARD</b>		<b>Code No.</b>	
05P0798, TB		—	

Junction Box IF-8900**ELECTRICAL PARTS LIST**

Unit	Junction Box IF-8900
PRINTED CIRCUIT BOARD	Code No.
05P0850, JUNCTION	—

# APPX. 6 PARTS LOCATION

## Transceiver unit FM-8900S

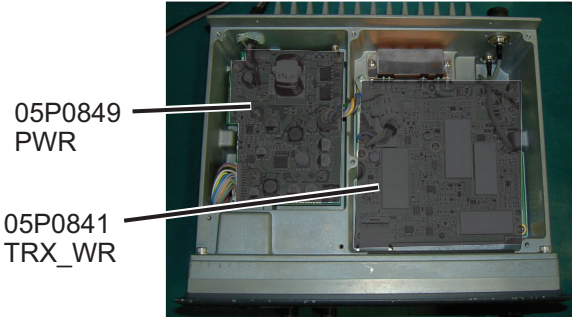

Top cover removed

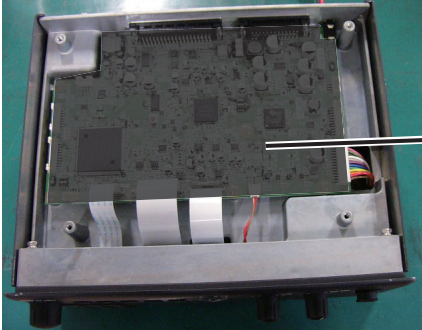

Bottom cover removed

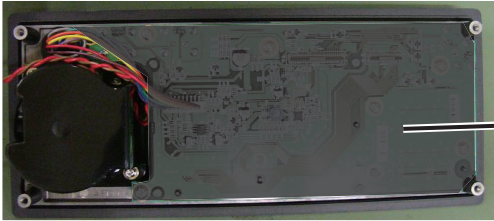

Back side of front panel

## Handset HS-2003

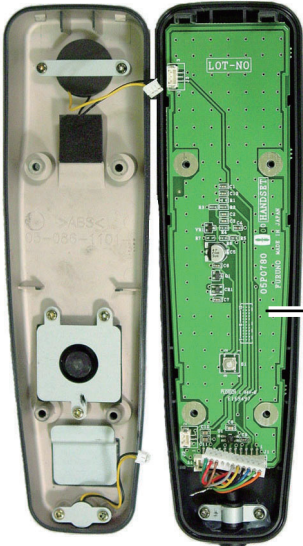

05P0780  
HANDSET



Remote station RB-8900 (HS-8900, HG-8900) / RB-8900-W (HS-8900-W, HG-8900-W)

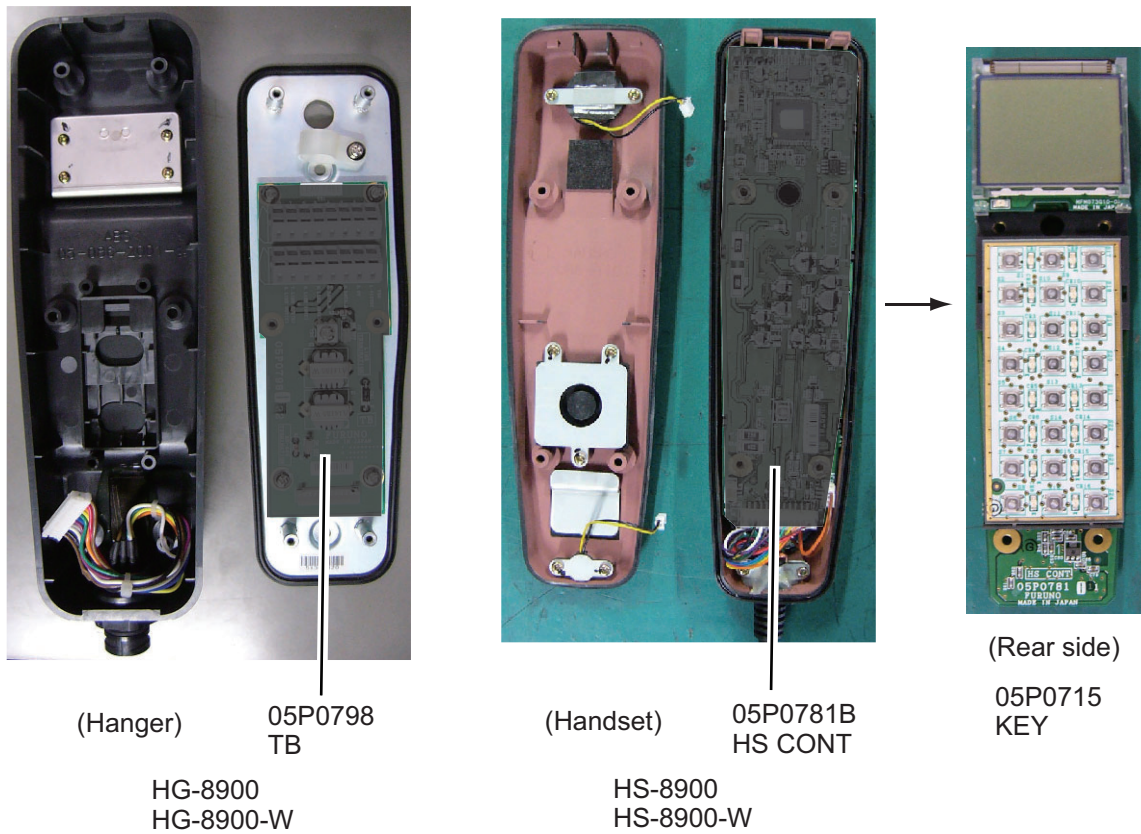

Junction box IF-8900

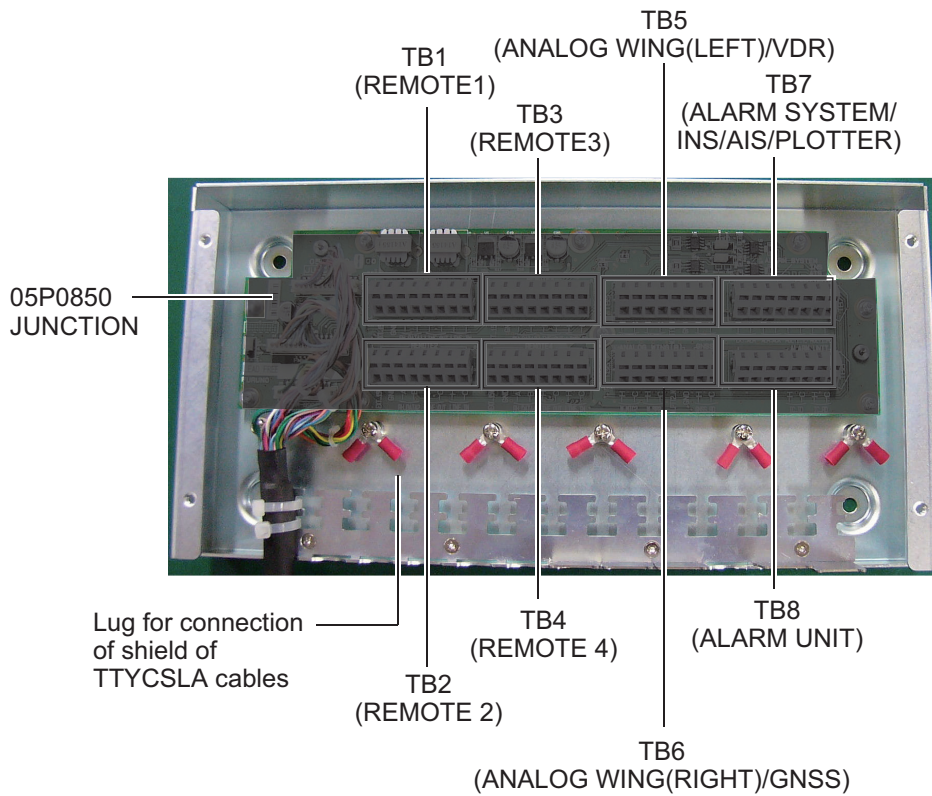

# APPX. 7 THERMAL PRINTER UTP-58E

## Printer usage cautions

- Do not disassemble or attempt to repair the printer.
- Do not allow water to enter the printer.
- Do not drop or jar the printer.
- Fix a paper jam after turning off the power.
- Turn off the power when there is some problem (for example, strange smell or smoke), and confirm that the trouble is not continuous.

## Paper usage cautions

The surface of the thermal paper is coated with special chemicals and the characters are printed out by thermo-chemical reaction.

- Use specified thermal roll paper.
- Keep in a cool, dry place.
- Keep paper away from hard objects, solvents and vinyl film to prevent paper discoloration.
- Use water-based glue (starch glue, synthetic glue, etc.) when pasting thermal paper.
- Adhesive tape can discolor the thermal paper. Use double-sided tape on the reverse side of the paper.
- Do not touch the paper with wet hands. Fingerprints may appear on the recording or the recording may become blurred.

## Specifications, Parts of the Printer

### **Specifications**

1. Thermal roll paper	Paper type: TP058-30CL (Code no. 000-154-047-11) Width of paper: 57 mm External diameter of roll paper: max $\phi$ 50 mm Length of paper: 30 m
2. Environmental conditions	Usable temperature: 0 to +50°C Usable humidity: 30 to 80% RH (no condensation) Storage temperature: -20 to +60°C Storage humidity: 20 to 85% RH (no condensation)

### **Parts**

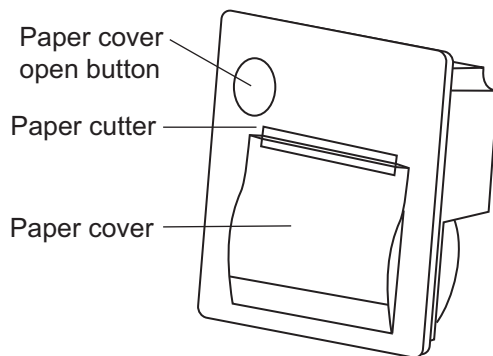

Front side

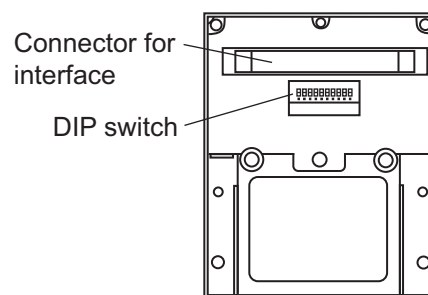

Rear side

How to set the DIP switch

The DIP switch functions to change printer specifications. Default specifications are shown as bold and italic face in the table below.

Pin no.	Function	OFF	ON
1 to 4	Communication system	See table 1.	
5	Bit length	<b>8 bit</b>	7 bit
6	Control system	<b>RTS/CTS</b>	Xon/Xoff
7 to 8	Command mode	See table 2.	
9	Upright/inverted printing	<b>Upright printing</b>	Inverted printing
0	Test pin*	<b>Normal mode</b>	(Setting disable)

\*: Do not change the setting for pin no. 0 except to upgrade the software. If the printer is turned on with pin no. 0 set for ON, the software will be overwritten.

*Table 1: Communication system*

Input method	Baud rate	Parity	DP1	DP2	DP3	DP4
Serial	38400	None	OFF	OFF	OFF	OFF
	19200		ON	OFF	OFF	OFF
	9600		OFF	ON	OFF	OFF
	4800		ON	ON	OFF	OFF
	2400		OFF	OFF	ON	OFF
	38400	Odd	ON	OFF	ON	OFF
	19200		OFF	ON	ON	OFF
	9600		ON	ON	ON	OFF
	4800		OFF	OFF	OFF	ON
	2400		ON	OFF	OFF	ON
	38400	Even	OFF	ON	OFF	ON
	19200		ON	ON	OFF	ON
	9600		OFF	OFF	ON	ON
	4800		ON	OFF	ON	ON
	2400		OFF	ON	ON	ON
Parallel	-	-	<b>ON</b>	<b>ON</b>	<b>ON</b>	<b>ON</b>

*Table 2: Command mode*

Command method	DP7	DP8
Mode 1 (20 digits, compatible with μTP-5820)	ON	ON
Mode 2 (24 digits, compatible with μTP-5824)	OFF	ON
Mode 3 (32 digits, compliant with ESC/POS)	<b>OFF</b>	<b>OFF</b>
HEX dump mode	ON	OFF

UTP-58E for RC-8900 (Rack Console) and PP-8800A (Printer)

Press the power switch and the power lamp goes on. When the lamp is on, the data received from the radiotelephone is printed. After completion of printing, feed paper out by pressing the line feed button.

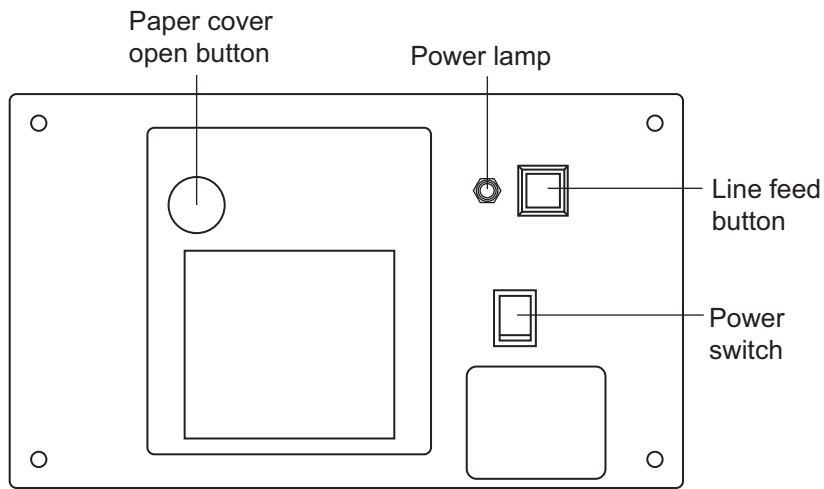

Paper replacement

1. Press the paper cover open button to open the paper cover.
2. Load the roll paper shown in the right figure.
3. Set the roll paper so that the end of the paper is outside the printer, and then close the cover by pressing both sides of the top of the paper cover.

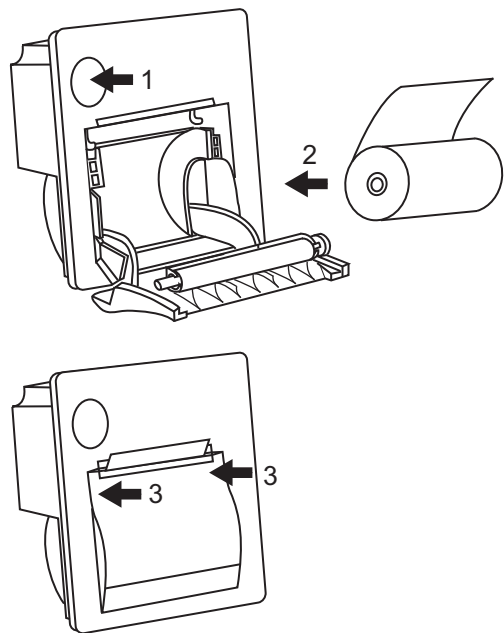

# APPX. 8 ALERT LIST AND CODES

---

## What is an alert?

“Alert” is a generic name for a notice to any unusual or potentially dangerous situation generated within the system.

Alerts are classified according to priority and category.

## Alert list

The ID for each alert is different, depending on whether there is a BAM (Bridge Alert Management) system or an AMS (Alert Management System) connected.

## Alert priority

Generally, there are two alert priorities: Warning and Caution.

**Warning:** Conditions or situations which require immediate attention for precautionary reasons, to make the bridge team aware of conditions which are not immediately hazardous, but may become so.

**Caution:** Awareness of a condition which continues to require attention out of the ordinary consideration of the situation or of given information.

**Note:** This equipment generates Warning and Caution only.

## Alert category

An alert is further classified by category, A, B or C, according to its degree of severity or source.

Category	Description
A	Category A alerts must be confirmed from the equipment that generated the alert. The followings are included. <ul style="list-style-type: none"><li>• Receipt of DISTRESS signal, DISTRESS ACK signal and RELAY signal</li><li>• Receipt of URGENCY signal and URGENCY ACK signal</li></ul>
B	Category B alerts are alerts where no additional information for decision support is necessary.
C	Category C cannot be approved on the CAM HMI due to the lack of information.

**Note:** This equipment does not provide the functional alert group function.

### How to Acknowledge a Warning

When an alarm or warning is generated, the buzzer sounds, the alert pop-up message appears and the corresponding icon appears and flashes. Confirm the contents of alert and press **CANCEL** key to close the pop-up message. For DSC messages, check the details of the message also

When multiple pop-up messages appear, confirm each message and press **CANCEL** key one by one to acknowledge each alarm or warning.

To recheck the contents of acknowledged alarm or warning, long press the MENU key or select ALARM menu to open the ALERT LIST.

### Responsibility Transfer

IEC62923 requires the use of the “responsibility transfer” function to reduce unnecessary alerts when some alternative function is available.

Below is the responsibility transfer flow in text and figure.

1. Warning is generated.
2. This equipment sends ALF of state V (active unacknowledged) to CAM.
3. CAM Checks if any alternative function is available.
4. CAM HMI sends “responsibility transfer command” ACN,O.
5. It suppress the alarm sounding and changes to responsibility transferred state.
6. It sends ALF of state O (active responsibility transferred) to CAM.

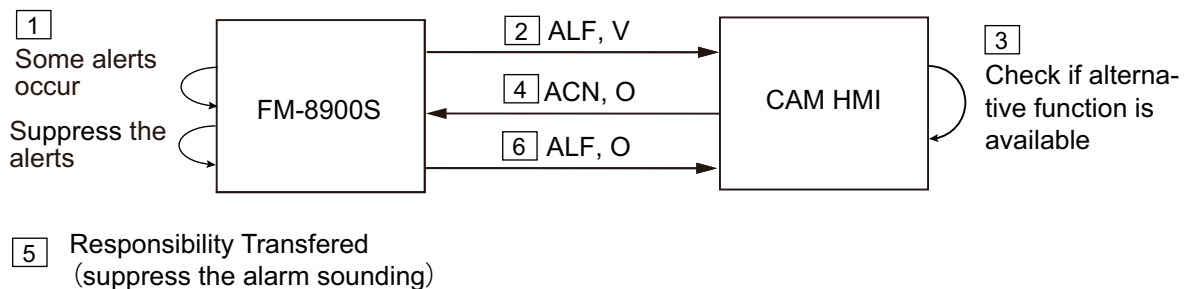

### Cancel Responsibility Transfer

1. CAM HMI does not send HBT sentence to Sensor A in specified time-out period.
2. FM-8900S regenerates the warning.
3. It sends ALF of state V (active unacknowledged) to CAM.  
Note the following concerning Responsibility Transfer:
  - When a Responsibility Transferred alert is acknowledged, the alert state becomes “Acknowledged.”
  - When the cause of a Responsibility Transferred alert is resolved, the alert state becomes “Normal.”
  - Category A alerts reject Responsibility Transfer. (ARC sentence is sent.)

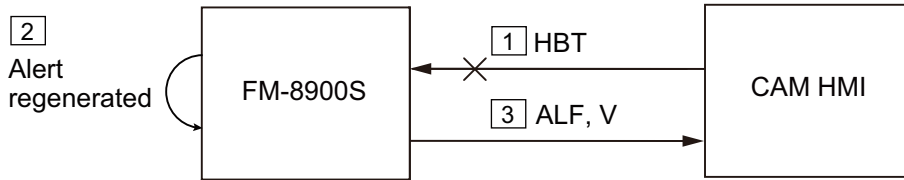

**Alert escalation**

All ALERT I/F2 Warning level alerts are escalated as Warning level alerts if they are not acknowledged or rectified within five minutes.

Caution level alerts are not escalated.

**Function Type**

Type P

**Interface**

IEC61162-2 (IF-8900 MULTI port)

**ALERT**

Alert ID	BAM ID	Displayed Message	Meaning (OM)	Measure (OM)
013	3013	Position data is not updated! Position was older than 4H. Update it.	Position data is not current.	Update current ship position manually.
014	610014 (FEC)	Lost position!Position was older than 23.5H.You must update position!	Position data is not current.	Update current ship position manually.
210	3115-1	RX PLL UNLOCK!CH:XX-Unable to receive.	RX circuit PLL is unlocked. Unable to receive.	Contact your dealer.
213	3115-2	DSC PLL UNLOCK!CH:70Unable to receive DSC message.	DS circuit is unlocked. Unable to receive DSC messages.	
220	3008-1	TX PLL UNLOCK!CH:XX-Unable to transmit.	TX circuit is unlocked. Unable to transmit.	
340	3008-2	TX power reduced.RF AMP heated.	RF amplifier is too hot. Transmissionpower is reduced.	Allow the transceiverunit to cool. If the problem persists,contact your dealer.
500	3122-x	DISTRESS ALERT message received! *	Distress level message received.	Check the contents of the message.
510	3122-x	URGENCY INDIVIDUAL message received! *	Urgency level message received.	
520	3123-x	SAFETY INDIVIDUAL message received! *	Safety level message received.	
530	3123-x	ROUTINE INDIVIDUAL message received! *	Routine level message received.	

APPX. 8 ALERT LIST AND CODES

Alert ID	BAM ID	Displayed Message	Meaning (OM)	Measure (OM)
–	–	Communication error with Remote HS!	Communication between the transceiver unit and a remote handset is interrupted or lost.	Check connection to handset. If the problem persists, contact your dealer.
630	3016	EPFS error!	No position data input for ten minutes. <b>Note:</b> This message does not appear when [INPUT TYPE] in the [POSITION] menu is set to [MANUAL].	Input position data.
–	–	Cannot print. Check printer.	Printer problem. Cannot print.	Check printer connection, power, paper.
–	–	Communication Error with BAM!	Position data is not current.	Update current ship position manually.
–	–	Unable to transmit!Hardware error occurs.Check alarm status.	Unable to transmit. TX circuit's PLL may be unlocked.	Contact your dealer.
–	–	System was rebooted.	An internal error has occurred. The system has rebooted.	The system will automatically restart. If the problem persists, contact your dealer.
–	–	The unit will not transmit any DSC call until own ship's MMSI is entered.	You tried to send a DSC message but your MMSI has not been registered in the equipment.	Enter the MMSI no. of your ship.

\*: The displayed message for received DSC messages changes according to the message contents, however the alert ID, priority, category and measures taken do not change.

**Note:** Priority and category for alerts is dependent on the alert management system in use. The tables above show the priority and category for BAMS.



**SPECIFICATIONS OF MARINE VHF RADIOTELEPHONE  
FM-8900S****1 GENERAL**

- |     |                      |  |
|-----|----------------------|--|
| 1.1 | Number of channels   | INT'L: 66<br>USA: 50<br>Weather: 10<br>Canada: 57<br>INLAND-WA: 57<br>Private: 20<br>Memory CH: 50 |
| 1.2 | Frequency stability  | Within $\pm 1.5$ kHz   |
| 1.3 | Communication system | Simplex/Semi-duplex  |
| 1.4 | Class of emission    | 16K0G3E (F3E) Voice, 16K0G2B (F2B) DSC   |
| 1.5 | Antenna impedance    | 50 ohms  |
| 1.6 | Display              | 4.3-inch color dot matrix LCD, 480 x 272 dots  |
| 1.7 | Visible distance     | 0.7 m nominal  |

**2 TRANSMITTER**

- |     |                     |                                 |
|-----|---------------------|---------------------------------|
| 2.1 | Frequency range     | 155.000 to 161.600 MHz          |
| 2.2 | Output power        | 25W max., 1W at power reduction |
| 2.3 | Frequency deviation | Within $\pm 5$ kHz              |

**3 RECEIVER**

- |     |                        |   |
|-----|------------------------|---|
| 3.1 | Frequency range        | Simplex: 155.000 to 161.600 MHz<br>Semi-duplex: 159.600 to 164.200 MHz              |
| 3.2 | Receiving system       | Double superheterodyne  |
| 3.3 | Intermediate frequency | 1st: 51.1375 MHz, 2nd: 62.5 kHz   |
| 3.4 | Sensitivity            | +6 dB $\mu$ V or less (20 dB SINAD)   |
| 3.5 | Channel selectivity    | 70 dB or more   |
| 3.6 | Spurious response      | 70 dB or more   |
| 3.7 | AF output              | Built-In speaker: 3W (4 ohms, THD: within 10%),<br>Handset earpiece: 2mW (150 ohms) |

**4 DSC**

- |     |                         |  |
|-----|-------------------------|--|
| 4.1 | Protocol                | Rec. ITU-R M.493, M.541, M.689, M.821            |
| 4.2 | Baud rate               | 1200 baud $\pm 30$ ppm max.                      |
| 4.3 | Modulation              | AFSK   |
| 4.4 | Frequency of modulation | 1700 $\pm 400$ Hz, Mark: 1300 Hz, Space: 2100 Hz |

**5 CH70 WATCH KEEPING RECEIVER**

- |     |                     |                        |
|-----|---------------------|------------------------|
| 5.1 | Receiving frequency | 156.525 MHz            |
| 5.2 | Receiving system    | Double superheterodyne |

- 5.3 Intermediate frequency 1st: 38.3625 MHz, 2nd: 37.5 kHz
- 5.4 Sensitivity 0 dB $\mu$ V or less (SER<1%)
- 5.5 Channel selectivity 70 dB or more
- 5.6 Spurious response 70 dB or more

## **6 INTERFACE**

- 6.1 Navigation data IEC61162-1
- Input sentences ACK, ACN, GGA, GLL, GNS, HBT, RMC, VDM, ZDA
- Output sentences ALC, ALF, ALR, ARC, DSC, DSE, HBT, TLL

## **7 POWER SUPPLY**

- 7.1 Power voltage 24 VDC (-10%, +30%)
- 7.2 Power consumption (with all options)
  - Transmit 4.7A max. at 25W output
  - Receive 2.3A max. at 4W audio output
  - Waiting 1.3A max.

## **8 ENVIRONMENTAL CONDITION**

- 8.1 Ambient temperature -15°C to +55°C
- 8.2 Relative humidity 93% or less at +40°C
- 8.3 Degree of protection
  - Transceiver unit (FM-8900S) IP20 (IP22: option)
  - Handset/Hanger (HS-2003/FP05-05510) IP24
  - Remote station RB-8900: IP22, RB-8900-W: IP56
  - Junction box IP20, IP22 (bulkhead mount, option)
- 8.4 Vibration IEC 60945 Ed.4

## **9 COATING COLOR**

- 9.1 Transceiver unit N2.5 (fixed)
- 9.2 Remote station/ handset N2.5 (fixed)
- 9.3 VHF console 7.5BG7/2, 2.5G7/2 or specified

# INDEX

---

## A

- Abbreviations .....AP-13
- Address book
  - deleting..... 5-13
  - editing..... 5-12
  - list..... 5-10
  - registration ..... 5-11
- Alarm lists..... 5-24
- All ships message
  - receiving..... 4-12
  - sending..... 4-11
- Audio alarms ..... 2-2
- Auto ACK setting..... 5-22

## B

- Brilliance
  - remote handset ..... 6-3
  - transceiver unit..... 1-3

## C

- Channel region..... 5-2
  - remote handset ..... 6-3
  - transceiver unit..... 1-4
- Channel selection
  - remote handset ..... 6-4
  - transceiver unit..... 1-4
- Contrast (remote handset) ..... 6-3
- Control description
  - remote handset ..... 6-1
  - transceiver unit..... 1-1

## D

- Daily test ..... 7-1
- Date and time setting ..... 5-6
- Digital interface .....AP-16
- Distress alert
  - canceling ..... 3-13
  - receiving..... 3-4
  - sending..... 3-1
- Distress relay
  - receiving..... 3-13
  - sending..... 3-10
- DSC messages ..... 2-1
- Dual channels (DW)..... 1-6

## E

- External alarm setting ..... 5-8

## G

- Group message
  - receiving..... 4-7
  - sending..... 4-6
- Group message preparation ..... 5-16

## I

- Icon .....AP-14
- Individual message
  - receiving..... 4-4

- sending..... 4-1
- Individual message preparation ..... 5-15
- Intercom ..... 1-9, 6-5

## L

- Log file
  - deleting..... 5-21
  - opening ..... 5-20

## M

- Maintenance..... 7-2
- Medical message
  - receiving ..... 4-19
  - sending..... 4-18
- Memory channel calling up
  - remote handset ..... 6-4
  - transceiver unit..... 5-2
- Memory configuration..... 5-3
- MENU screen open/close ..... 5-1
- Menu tree .....AP-1

## N

- Neutral message
  - receiving..... 4-17
  - sending..... 4-16

## P

- Parts list .....AP-24
- Parts location .....AP-26
- Polling request message..... 4-15
- Position message
  - receiving..... 4-15
  - sending..... 4-13
- Position setting..... 5-4
- Power on/off
  - remote handset ..... 6-2
  - transceiver unit..... 1-2
- Printing message ..... 5-4
- Priority ..... 1-8
- Propose channel ..... 5-23
- PSTN message
  - receiving..... 4-10
  - sending..... 4-8
- PSTN message preparation ..... 5-17

## R

- Replay function ..... 1-14
- RT application setting..... 5-9
- RT screen
  - remote handset ..... 6-2
  - transceiver unit..... 1-2

## S

- Scanning channels..... 1-7
- Session ..... 1-10
- Sound setting
  - remote handset ..... 6-7
  - transceiver unit..... 5-23

## INDEX

Speaker	
remote handset .....	6-5
transceiver unit.....	1-5
Special message.....	5-22
<b>T</b>	
Test call.....	7-3
Test message preparation .....	5-18
Timeout setting .....	5-6
Transmission	
remote handset .....	6-4
transceiver unit.....	1-5
Troubleshooting .....	7-2
<b>U</b>	
UTP-58E .....	AP-28
<b>V</b>	
VHF channel lists .....	AP-3

## Declaration of Conformity

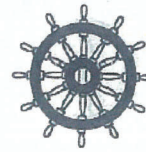

# 0560

We FURUNO ELECTRIC CO., LTD.

(Manufacturer)

9-52 Ashihara-Cho, Nishinomiya City, 662-8580, Hyogo, Japan

(Address)

declare under our sole responsibility that the product

VHF RADIOTELEPHONE FM-8900S  
(Serial No. 4500/4504/4512/4513/4514-xxxx)

(Model name, type number)

to which this declaration relates conforms to the following standard(s) or normative document(s)

IMO Resolution A.385(X), A.524(13), A.694(17),	EN 301 843-1/2 V2.2.1: 2017
A.803(19), MSC.36(63), MSC.68(68)/A1,	EN 301 925 V1.5.1: 2017
MSC.97(73), MSC.302(87), MSC/Circ.862,	IEC 60529 Ed.2.1: 2001
MSC.1/Circ.1460	IEC 60945 Ed.4.0: 2002 incl.Corr.1: 2008
ITU-R M.489-2, M.493-15, M.541-10,	IEC 61097-3 Ed.2.0: 2017
M.689-3, M.821-1	IEC 61162-1 Ed.5.0: 2016
EN 300 338-1 V1.6.1: 2021	IEC 62288 Ed.2.0: 2014
EN 300 338-2 V1.5.1: 2020	IEC 62923-1/2 Ed.1.0: 2018
EN 301 033 V1.4.1: 2013	

(title and/or number and date of issue of the standard(s) or other normative document(s))

For assessment, see

- EC type-examination (Module-B) certificates No. 222120007/AA/00 (MED/5.1) and 222120010/AA/00 (MED/5.2) issued by Telefication, The Netherlands.
- Product Quality System (Module D) certificate No. P 112 (Issue 65) issued by Telefication, The Netherlands.

This declaration is issued according to the Directive 2014/90/EU of the European Parliament and of the Council on marine equipment, and the Implementing Regulation (EU) 2021/1158.

On behalf of Furuno Electric Co., Ltd.

Nishinomiya City, Japan  
26 April 2022

(Place and date of issue)

Akihiko Kanechika  
Department General Manager  
Quality Assurance Department

(name and signature or equivalent marking of authorized person)