

MOBILITY 42G

7-in-1 Cellular & Wi-Fi Antenna System with GPS Receiver

Overview

- Built for 5G**
 Omni-directional 4x4 MIMO mobile antenna for the best performance.
- C-Band support**
 Exceptional performance in 3.3 and 4.2 GHz frequency range allowing to get a massive throughput speed boost.
- Ultra wide bandwidth**
 Wide frequency range (600-6000MHz) supporting LTE and 5G
- Wi-Fi**
 2x2 MIMO dual band (2.4GHz & 5GHz) high gain omnidirectional antennas
- Robust design**
 IP68 rated, low profile and durable housing in Black or White color options.

Applications

- Public Safety and mission critical connectivity
- Mobile Healthcare
- Transportation Connectivity

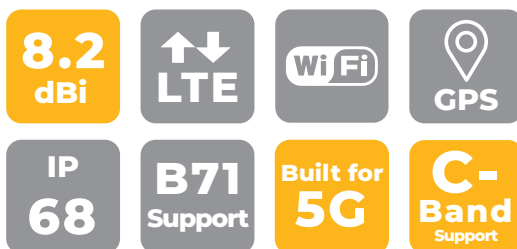

Specification

Cellular

Antenna elements	4 elements
Cellular frequencies#	4.4dBi@617-960MHz 7.8dBi@1710-2700MHz 7.9dBi@3400-4200MHz 8.2dBi@5000-6000MHz
Cellular bands	LTE bands B1 to B86 (except B31, B72, B73, B87, B88), 5G bands n1 to n99
VSWR	< 2.5 over 95% of the band
Feed power handling	10W
Input impedance	50 Ω
Polarisation	Linear
Ground plane	Not required

Wi-Fi

Antenna elements	2 elements
Peak Gain & Frequencies	5.0dBi: 2400-2500MHz 7.5dBi: 5000-6000MHz
VSWR	< 2.5
Feed power handling	10W
Input impedance	50 Ω
Polarisation	Linear

GPS

Frequency range	1561-1602 MHz
Peak Gain & Frequencies	0.5dBi@1575MHz 1.6dBi@1602MHz
VSWR	< 2 dB
Output return loss	10dB max
LNA Gain	28 ±3dB
Noise figure	1.5dB max at 3.3V
Operating Voltage	3.3V
Power consumption	8.5 ±2.5mA at 3.3V

Cable (LTE / 5G, Wi-Fi)

Type	CFD-200
Loss	0.33 dB/m @ 900 MHz 0.49 dB/m @ 2000 MHz 0.55 dB/m @ 2500 MHz 0.87 dB/m @ 5800 MHz
Diameter	0.2" / 5.0mm
Jacket	Half matt PVC, UV resistant
Cellular Termination	QMA male, SMA male
Wi-Fi Termination	QMA male, RP-SMA male

Cable (GPS)

Type	RG-174
Loss	3.4 dB/m @ 1000 MHz 4.9 dB/m @ 1800 MHz
Diameter	0.1" / 2.7mm
Jacket	Half matt PVC, UV resistant
Termination	QMA male, SMA male

Mounting

Supported types	Panel, wall, pole
Mounting hole	1 11/16" / 43mm
Max panel thickness	19/32" / 15mm

Mechanical

Product dimensions	(Height) 2.28" / 58mm (spigot not included) (Diameter) 8.19" / 208mm
Packaged dimensions	9.09" x 8.50" x 6.14" 231 x 216 x 156 mm
Radome material	UV stable PC

Package contents

Antenna	Mobility 42G
Accessories	Wall/pole mount Double sided 3M adhesive pad (Diameter: 8.19" / 208 mm Thickness: 0.08" / 2 mm)

Environmental, compliance

IP rating	IP68
Operating temperature	-40° - 176°F / -40° - 80°C
Storage temperature	-40° - 176°F / -40° - 80°C
Compliance	RoHS, REACH, WHEE
Wind Survivability	137mph, 220 km/h
Enclosure flammability	UL 94 HB
Cable flammability	UL 758 (VW-1)
UV resistance	UL 746C (F1 long-term UV exposure)
Salt Spray	MIL-STD 810F/ASTM B117

Mobility 42G

Measured peak Gain on 600x600mm (23.6"x23.6") ground plane excluding cable loss.

Ordering Information

Mobility 42G

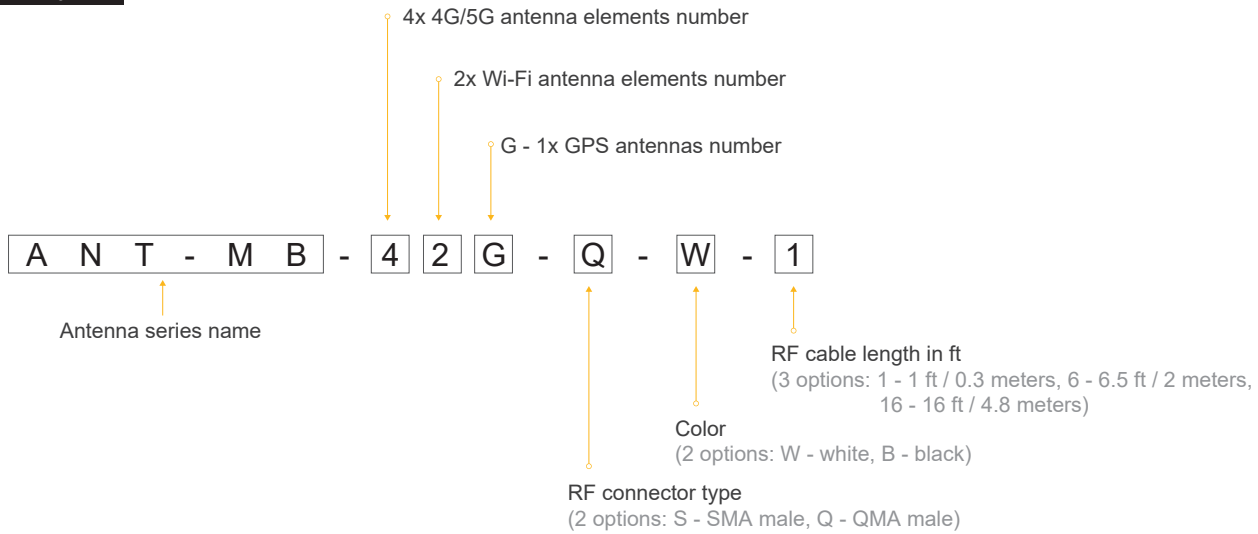

Product Code	Description
ANT-MB-42G-S-W-6	4xLTE/5G, 2x Wi-Fi, 1xGPS 600-6000MHz, IP68, SMA, White, 6.5 ft / 2m
ANT-MB-42G-S-B-6	4xLTE/5G, 2x Wi-Fi, 1xGPS 600-6000MHz, IP68, SMA, Black, 6.5 ft / 2m
ANT-MB-42G-S-W-16	4xLTE/5G, 2x Wi-Fi, 1xGPS 600-6000MHz, IP68, SMA, White, 16 ft / 4.8m
ANT-MB-42G-Q-W-1	4xLTE/5G, 2x Wi-Fi, 1xGPS 600-6000MHz, IP68, QMA, White, 1 ft / 0.3m
ANT-MB-42G-Q-W-6	4xLTE/5G, 2x Wi-Fi, 1xGPS 600-6000MHz, IP68, QMA (Cellular, GPS), RP-SMA (Wi-Fi), White, 6.5 ft / 2m
ANT-MB-42G-Q-B-1	4xLTE/5G, 2x Wi-Fi, 1xGPS 600-6000MHz, IP68, QMA, Black, 1 ft / 0.3m
ANT-MB-42G-Q-B-6	4xLTE/5G, 2x Wi-Fi, 1xGPS 600-6000MHz, IP68, QMA (Cellular, GPS), RP-SMA (Wi-Fi), Black, 6.5 ft / 2m

Extension cable

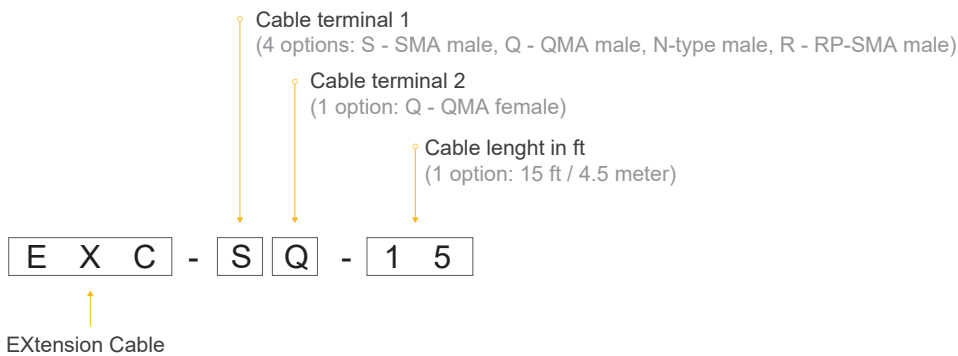

LTE/GPS elements

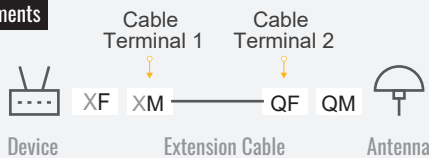

Wi-Fi elements

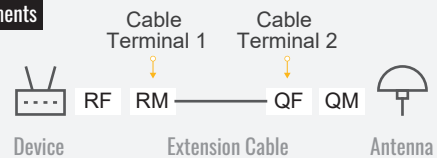

Product Code	Element type	Description
EXC-SQ-15	LTE/GPS elements	Extension coax cable, SMA male to QMA female connector, 15ft / 4.5m
EXC-QQ-15	LTE/GPS elements	Extension coax cable, QMA male to QMA female connector, 15ft / 4.5m
EXC-NQ-15	LTE/GPS elements	Extension coax cable, N-type male to QMA female connector, 15ft / 4.5m
EXC-RQ-15	Wi-Fi elements	Extension coax cable, RP-SMA male to QMA female connector, 15 ft / 4.5m

Mobility 42G

Featured Add-on

Product Code	Description
ACW-661	3M Double-sided Adhesive Antenna Mounting Gasket
ACW-881	Wall/pole L-mount Antenna mounting kit (white)
ACW-884	Wall/pole L-mount Antenna mounting kit (black)
ACW-651	Maritime 1" 14TPI Female to Mobility Antenna thread
ACW-653	Maritime 1 1/4" 11TPI male adapter

Mobility 42G

Technical Drawing



Mobility 42G



Cellular Antenna VSWR

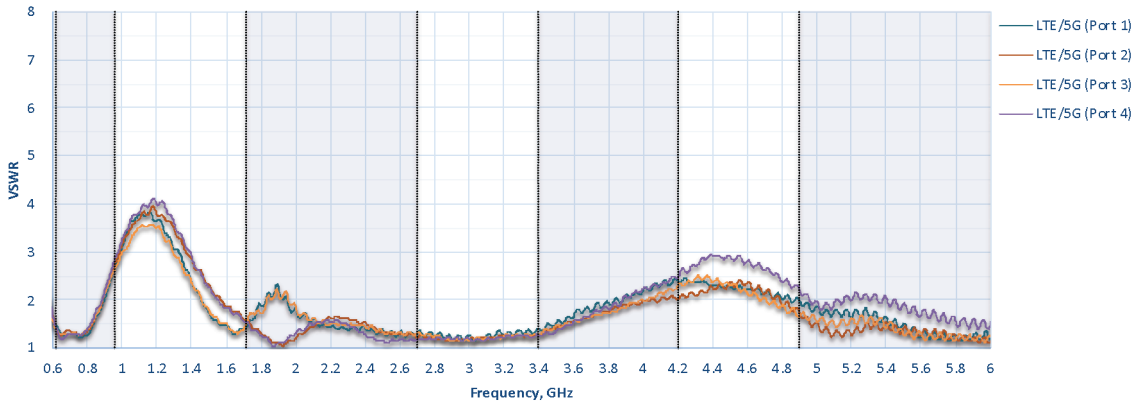

Cellular Antenna Gain

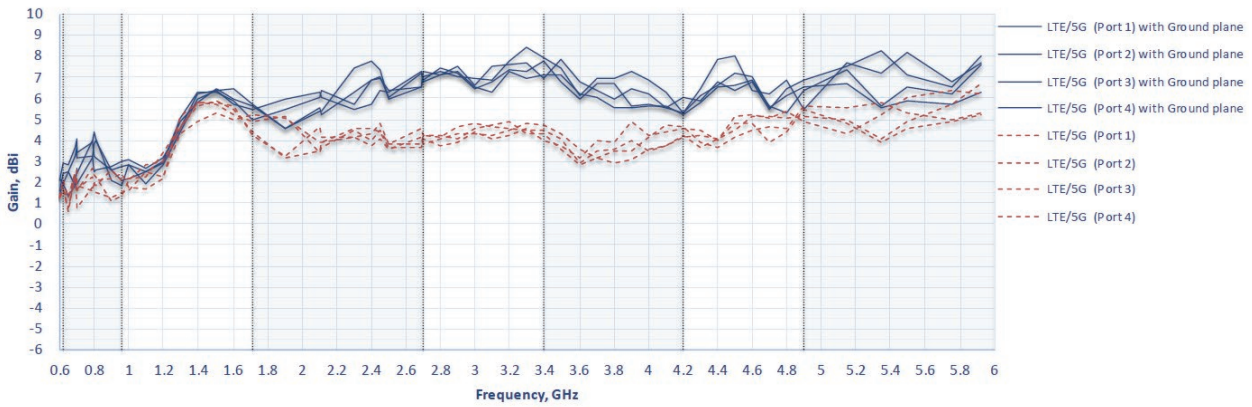

Cellular Antenna Efficiency

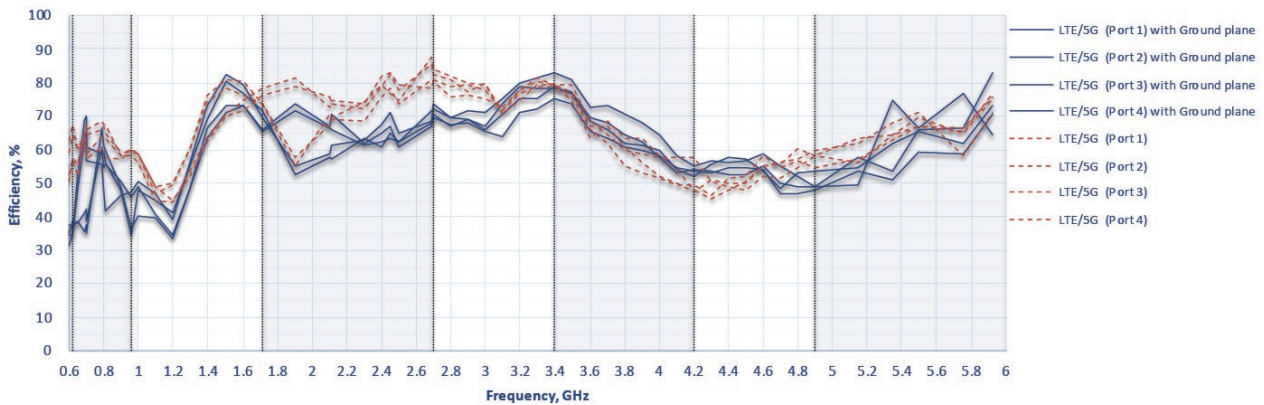

Wi-Fi Antenna VSWR

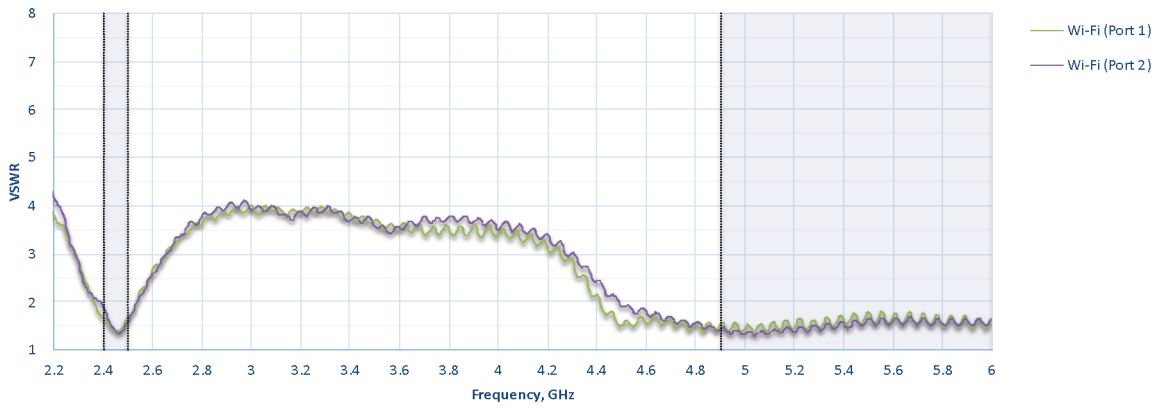

Wi-Fi Antenna Gain

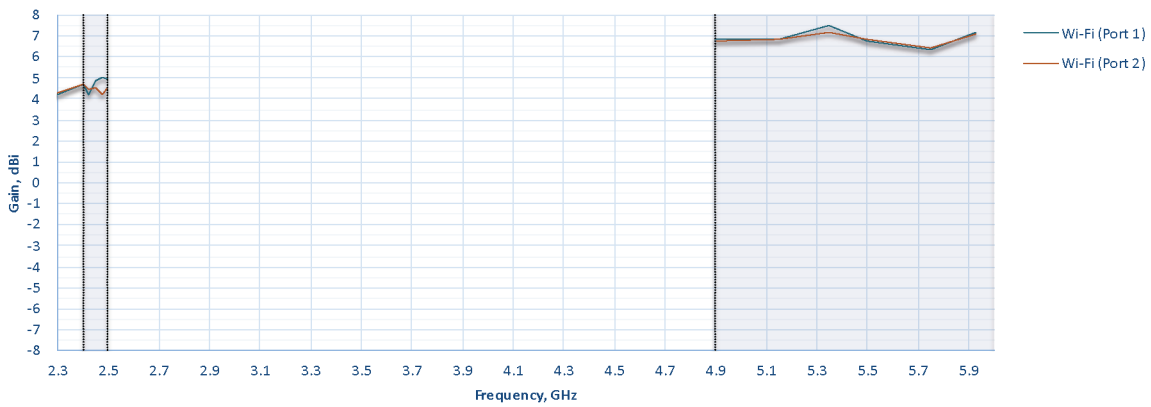

Wi-Fi Antenna Efficiency

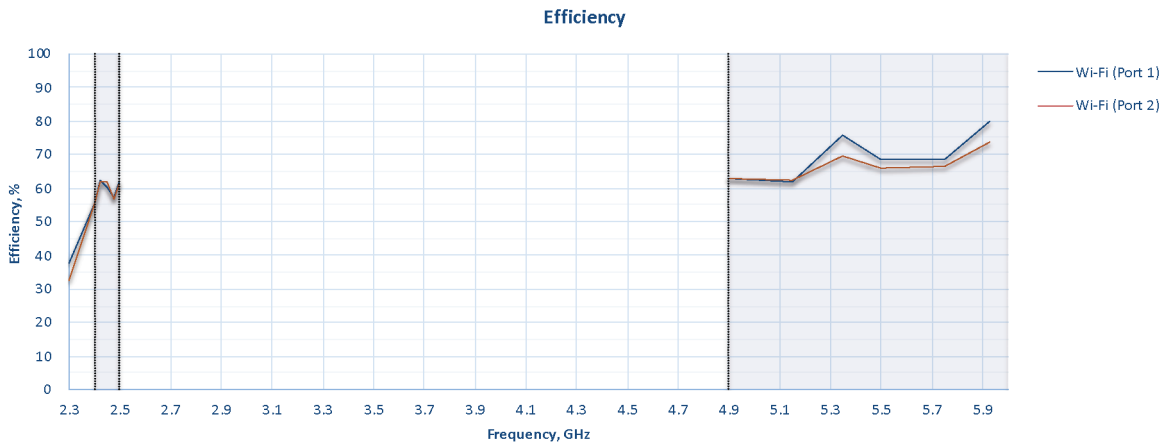

Mobility 42G

Antenna Isolation

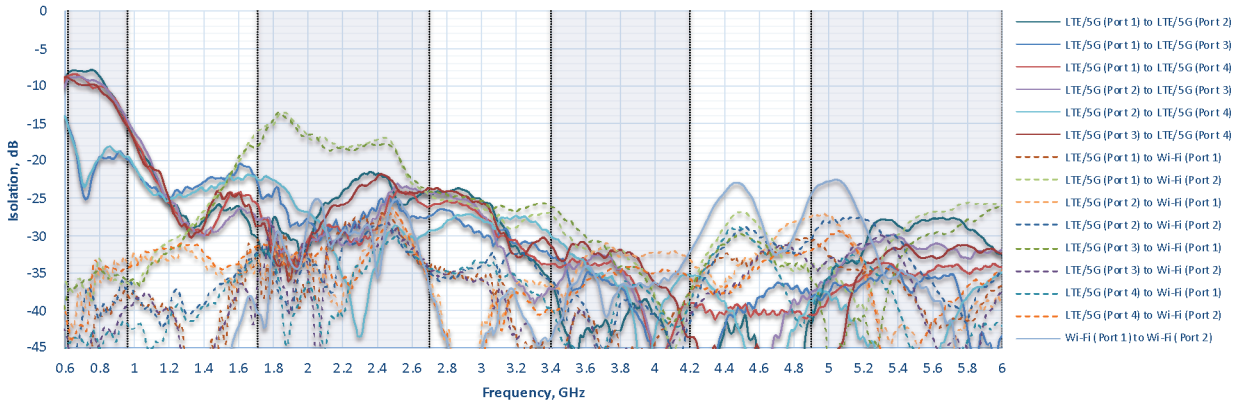

Mobility 42G

LTE Radiation Patterns (Azimuth)

617-960 MHz

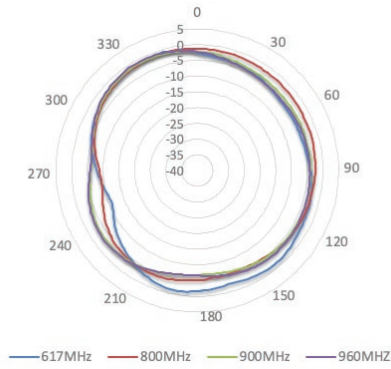

3400-3800 MHz

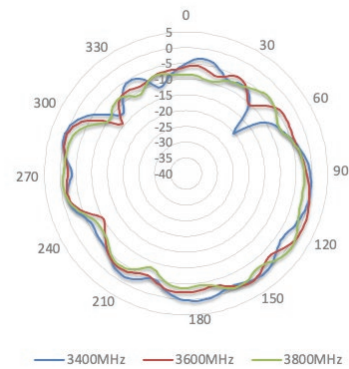

1710-2100MHz

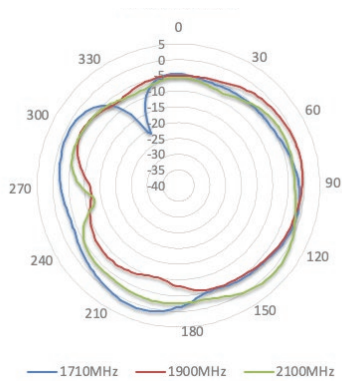

4200-5150 MHz

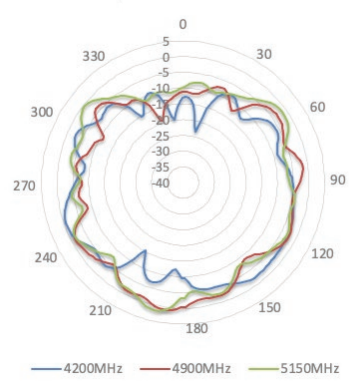

2300-2700 MHz

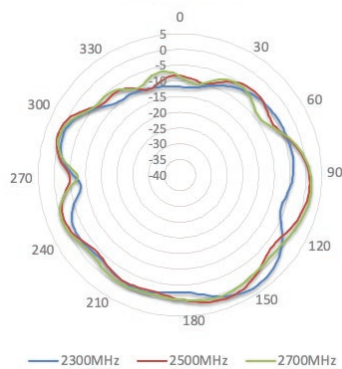

5350-5925 MHz

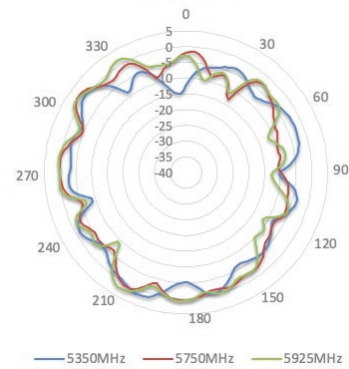

Mobility 42G

LTE Radiation Patterns (Elevation 1)

617-960 MHz

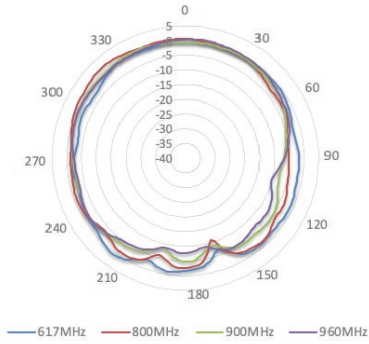

3400-3800 MHz

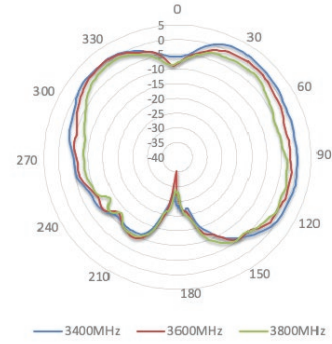

1710-2100MHz

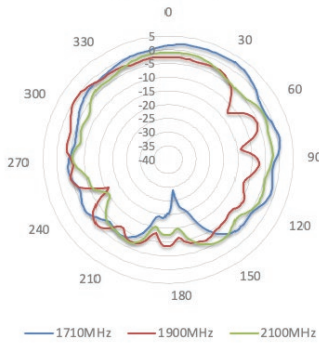

4200-5150 MHz

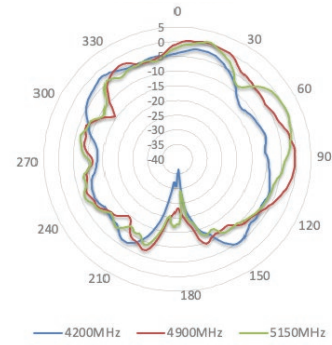

2300-2700 MHz

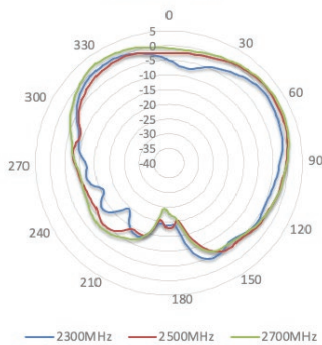

5350-5925 MHz

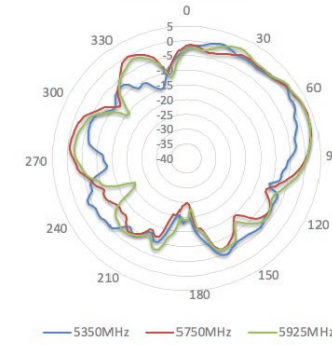

Mobility 42G

LTE Radiation Patterns (Elevation 2)

617-960 MHz

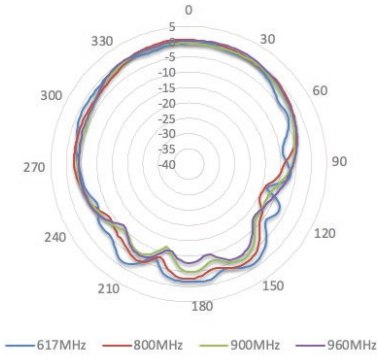

3400-3800 MHz

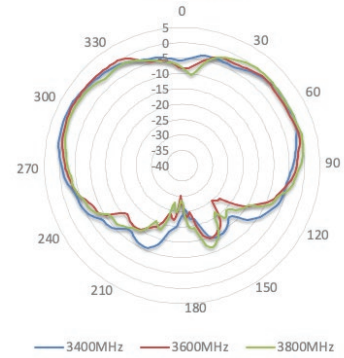

1710-2100MHz

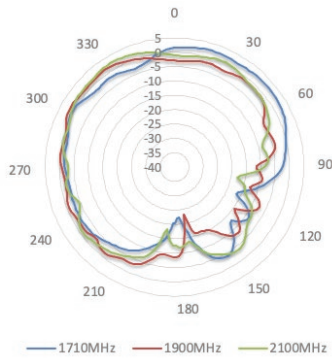

4200-5150 MHz

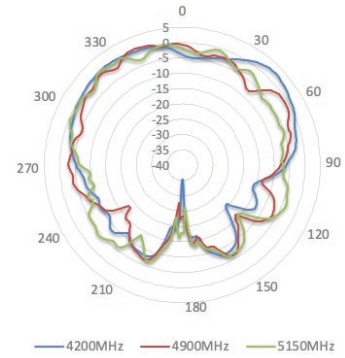

2300-2700 MHz

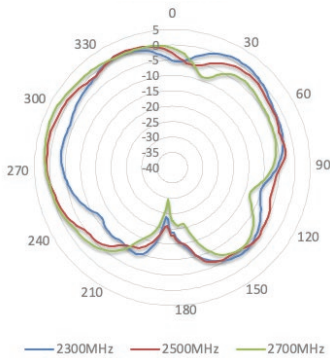

5350-5925 MHz

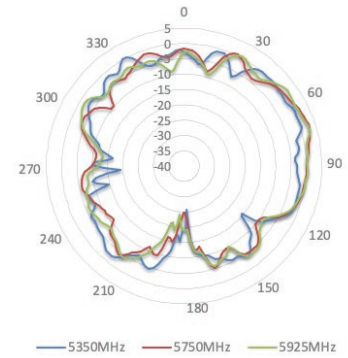

Mobility 42G

Wi-Fi Radiation Patterns (Azimuth)

2400-2500 MHz

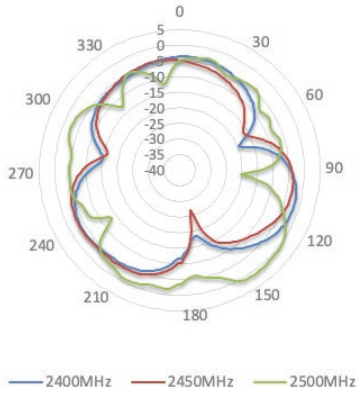

4900-5350 MHz

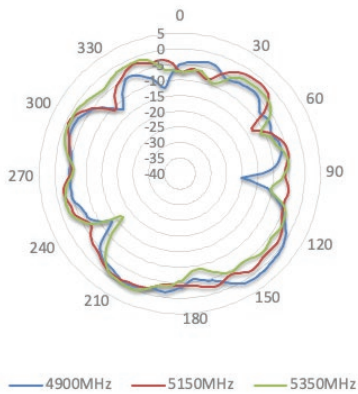

5550-5950 MHz

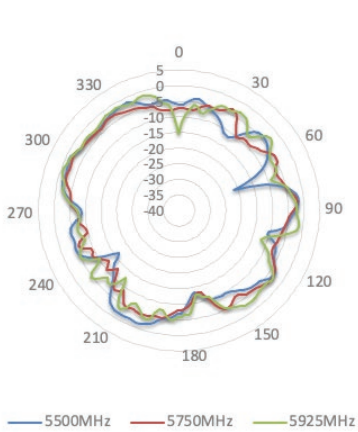

Wi-Fi Radiation Patterns (Elevation 1)

2400-2500 MHz

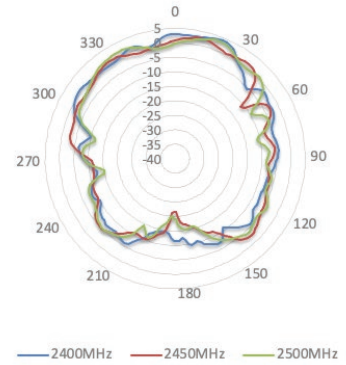

4900-5350MHz

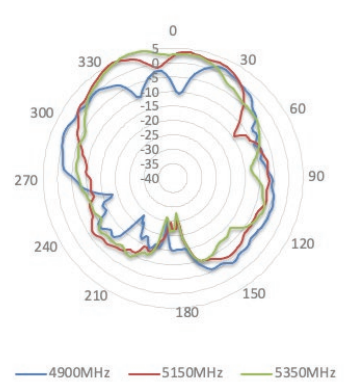

5550-5950 MHz

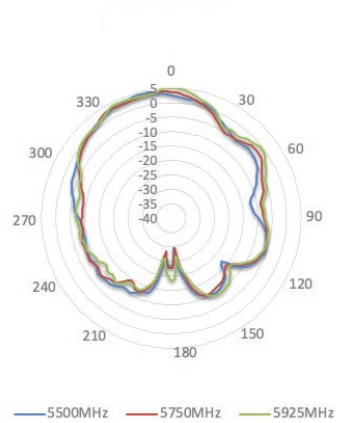

Mobility 42G

Wi-Fi Radiation Patterns (Elevation 2)

2400-2500 MHz

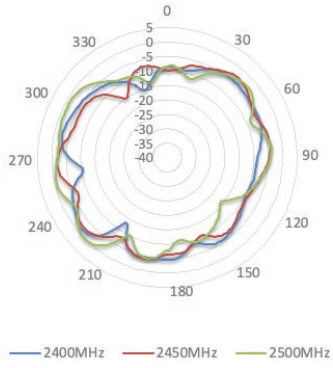

4900-5350 MHz

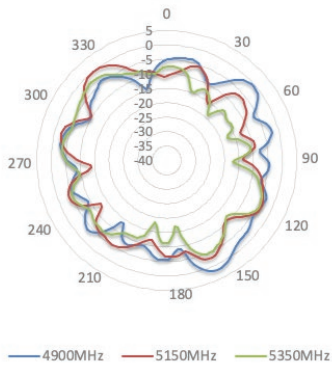

5550-5950 MHz

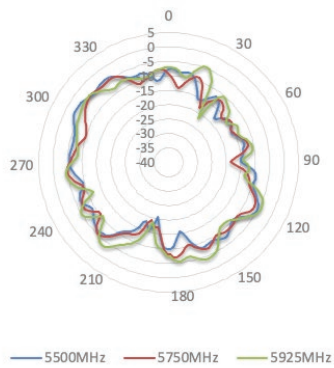

Mobility 42G

Installation Recommendation

Panel Mount



Mobility 42G

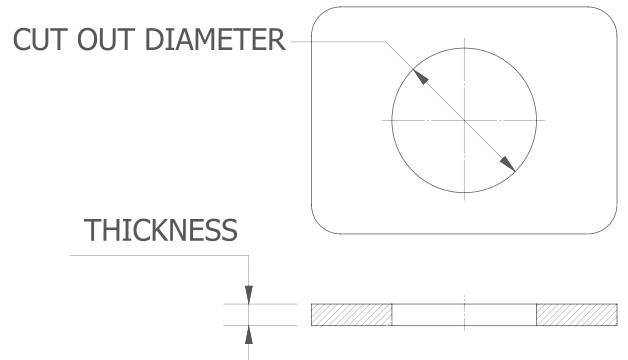

Notes

- Cover panel surface to protect the paint work. When drilling a hole, start with a small one, then increase it.
- Cut out diameter should be 1 11/16" / 43mm.
Maximum allowed panel thickness - 19/ 32" / 15mm.
- After drilling, clean up the surface and apply some paint around the hole to prevent corrosion. Attach the antenna.

Installation Recommendation

Pole Mount



Mobility 42G



Installation Recommendation

Horizontal Pole Mount



Mobility 42G



Installation Recommendation

Wall Mount



Mobility 42G

